



RECOMENDACIONES

Recommandations - Consigli - Recomendações -
Aanbevelingen - Empfehlungen

- ES** Los tacos y tornillos incluidos no son aptos para paredes de pladur.
- EN** The included plugs and screws are not suitable for drywall.
- DE** Die mitgelieferten Dübel und Schrauben sind nicht für Gipswände geeignet.
- FR** Les chevilles et les vis fournies ne conviennent pas aux murs en placoplâtre.
- IT** I tasselli e le viti in dotazione non sono adatti alle pareti in cartongesso.
- NL** De meegeleverde pluggen en schroeven zijn niet geschikt voor gipswanden.
- PT** As buchas e os parafusos incluídos não são adequados para paredes de pladur.



Typ:L

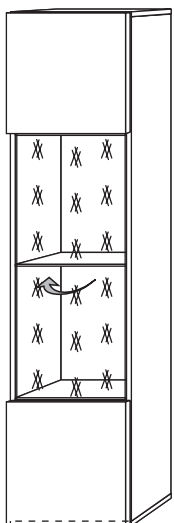

Typ:P

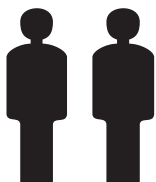
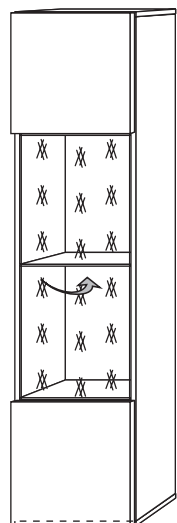

2 Personen
2 Osoby

Pflegehinweis!

Bitte nur mit einem Staubtuch oder einem feuchten Lappen reinigen.

KEINE scheuernde Putzmittel verwenden!

Wskazówka dotycząca pielęgnacji!

Proszę czyścić tylko suchą lub lekko wilgotną szmatką do kurzu. Nie używać żadnych środków szorstkich!

Max. zulässige Belastungen von Einlegeböden in kg:

Maksymalne obciążenie półek w kg:

Stärke/Gr.	Spanplatte/Plyta		
Länge/Dł. mm	15	18	22
0<400			
401<600	40	40	40
601<800	24		
801<1000	15	30	

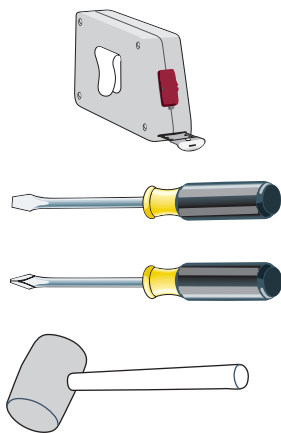
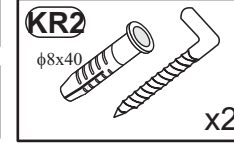
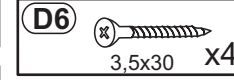
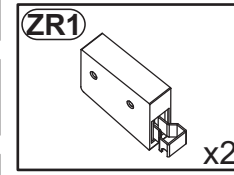
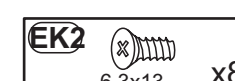
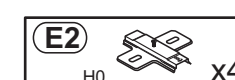
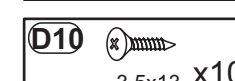
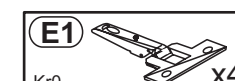
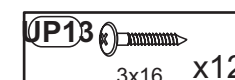
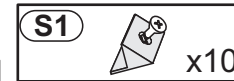
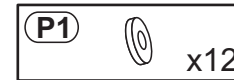
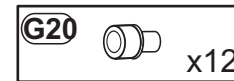
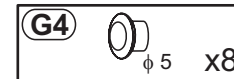
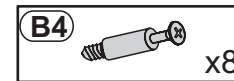
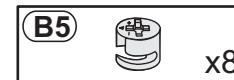
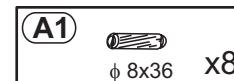
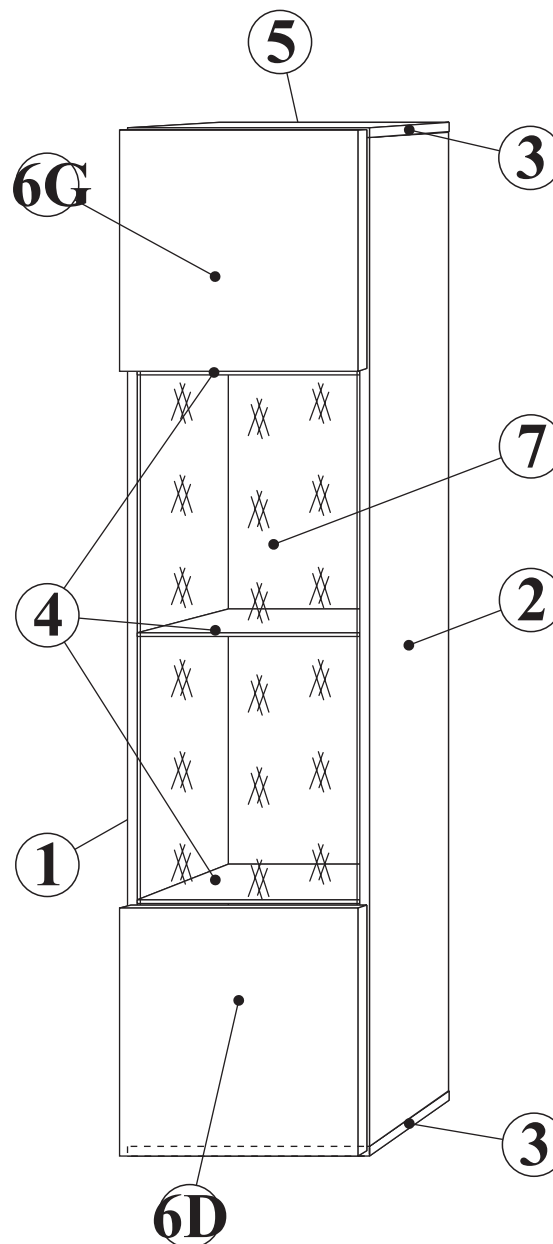

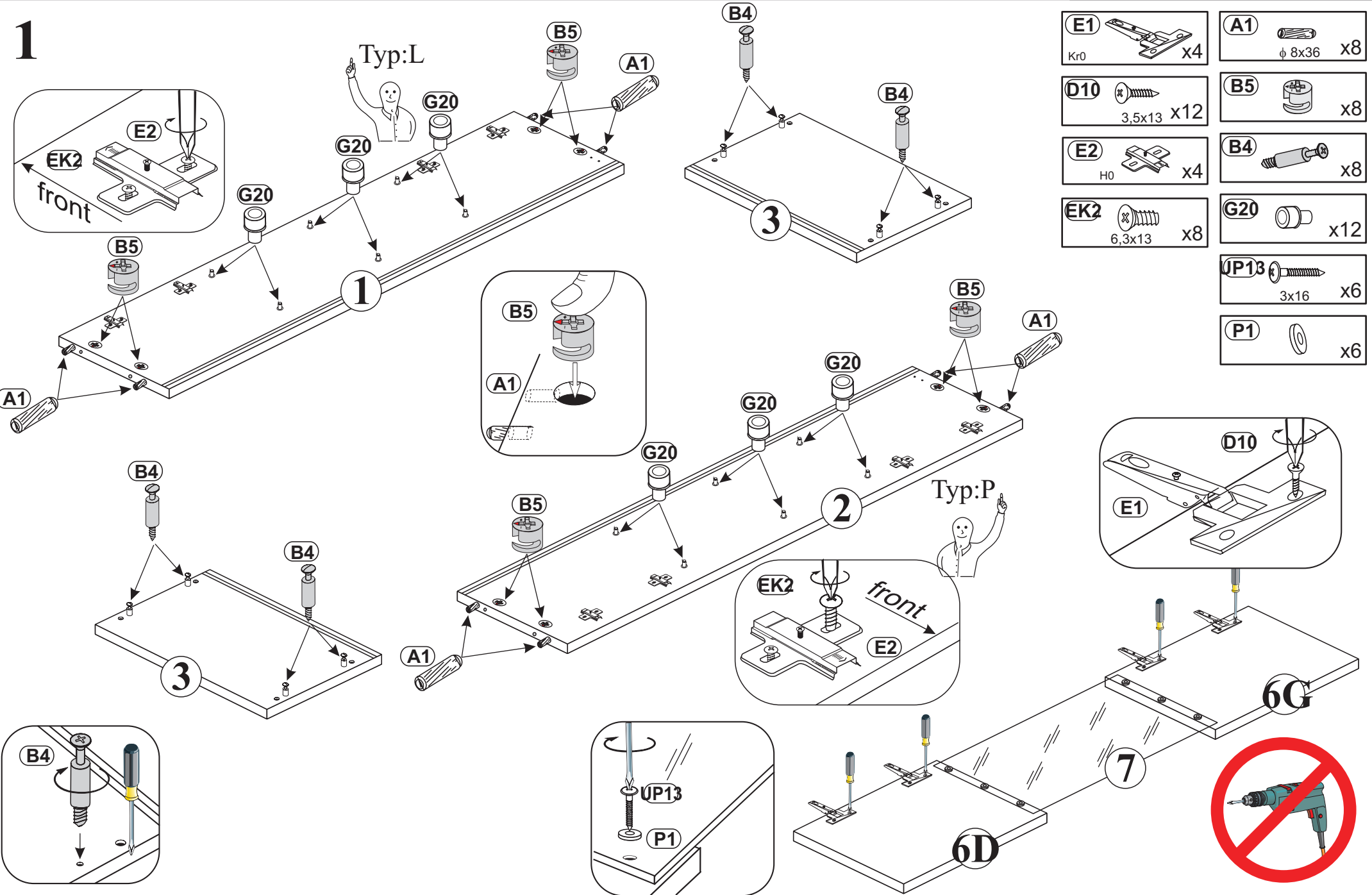

1





E1  x4
Kr0

A1  x8
φ 8x36

D10  x12
3,5x13

B5  x8

E2  x4
H0

B4  x8

EK2  x8
6,3x13

G20  x12

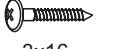
UP13  x6
3x16

P1  x6

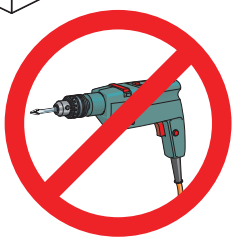
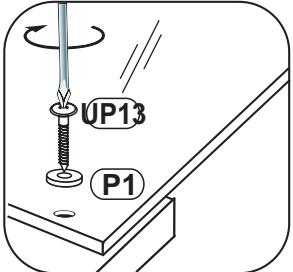
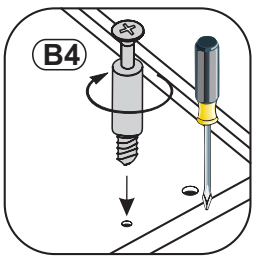
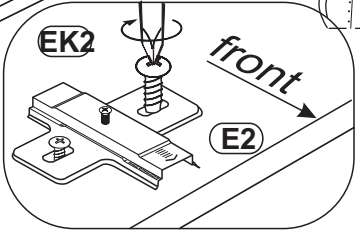
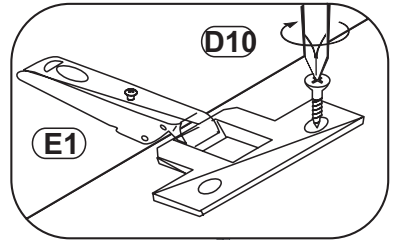

2

Typ:L

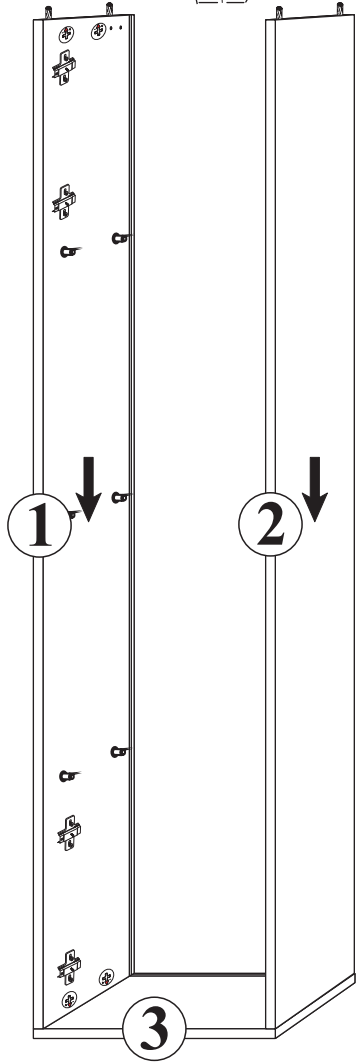

Typ:P

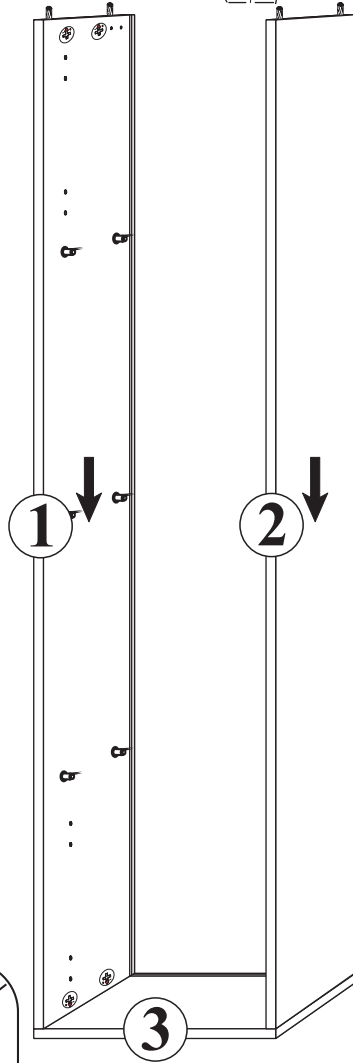

3

Typ:L

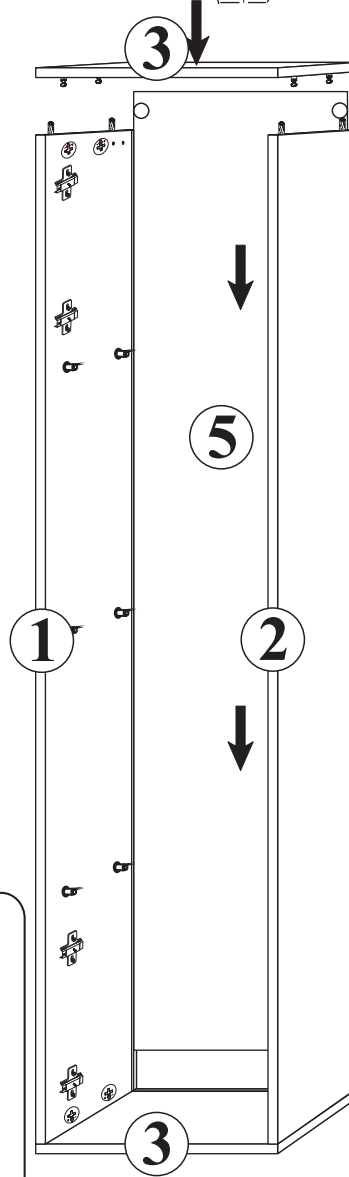

Typ:P

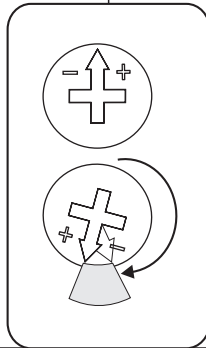
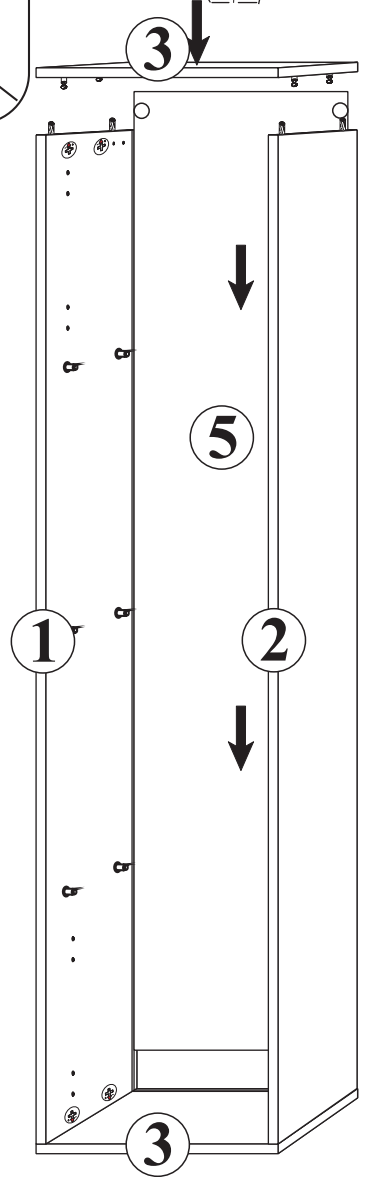
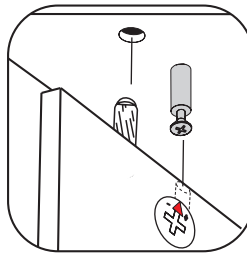

4

a=b

S1  x12

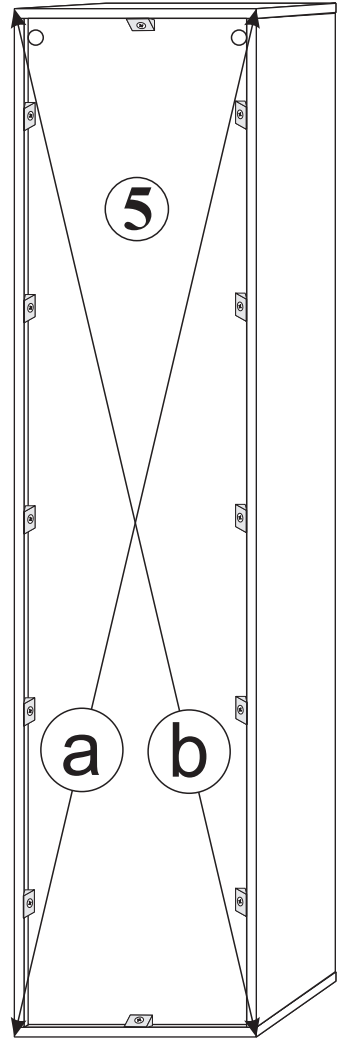
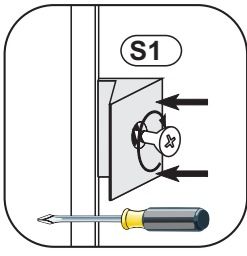

5

Typ:L 

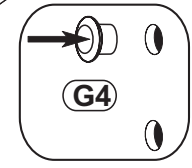
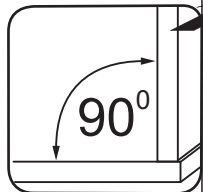
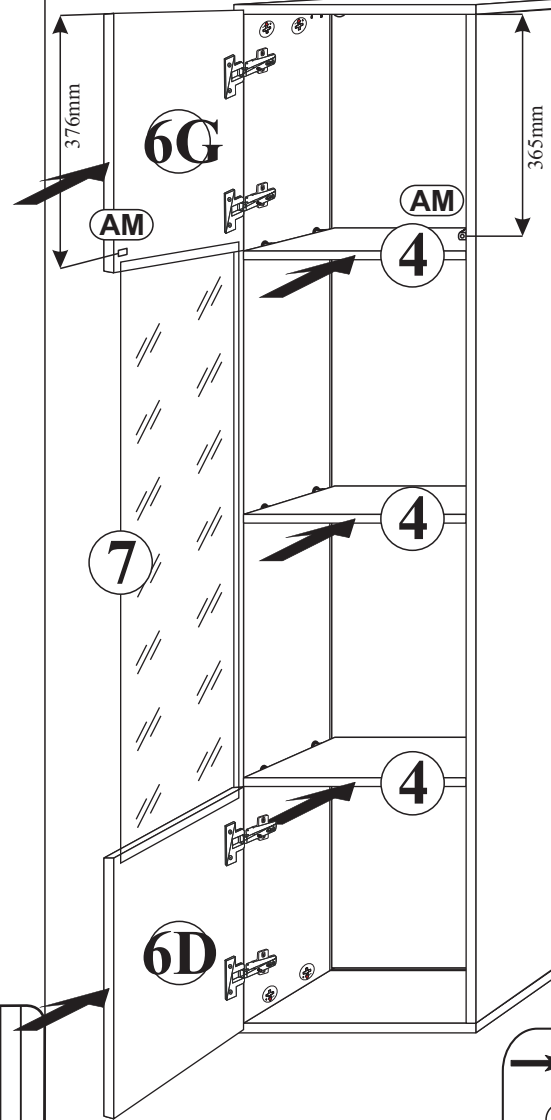

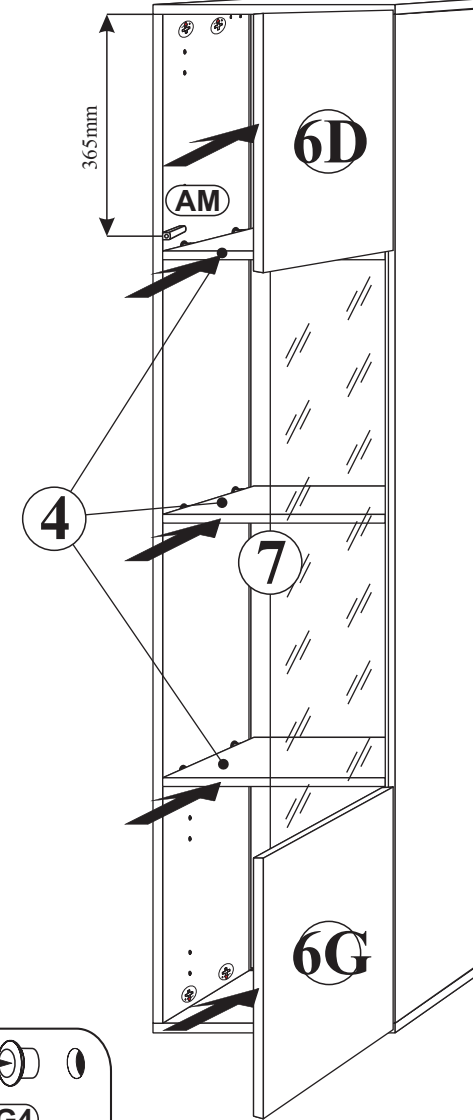

Typ:P 

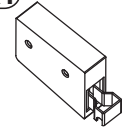

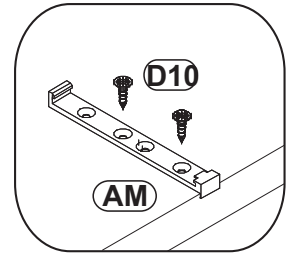
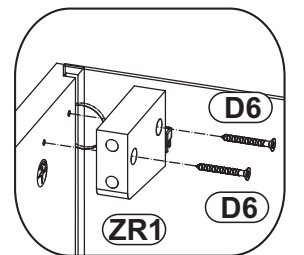
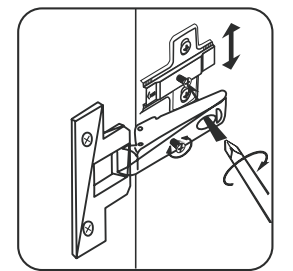

ZR1  x2

D6  3,5x30 x4



D10  3,5x13 x2

AM  x1

G4  ϕ 5 x8

6

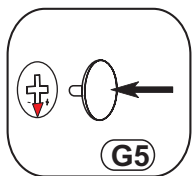
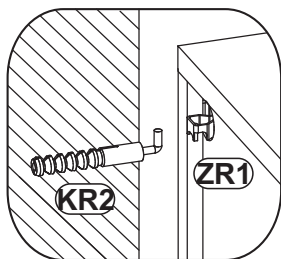
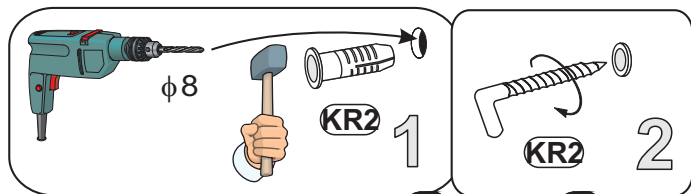

PL Złączone kolki do zawieszania bryły, do stosowania wyłącznie do ścian betonowych, do innych ścian należy odpowiednio dokupić.

D Die beigefügten Dübel zum Aufhängen des Elements dürfen nur bei Betonwänden eingesetzt werden, bei anderen Wandarten müssen entsprechende Dübel zugekauft werden.

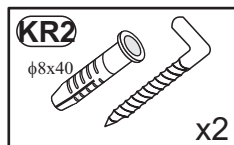
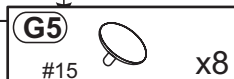
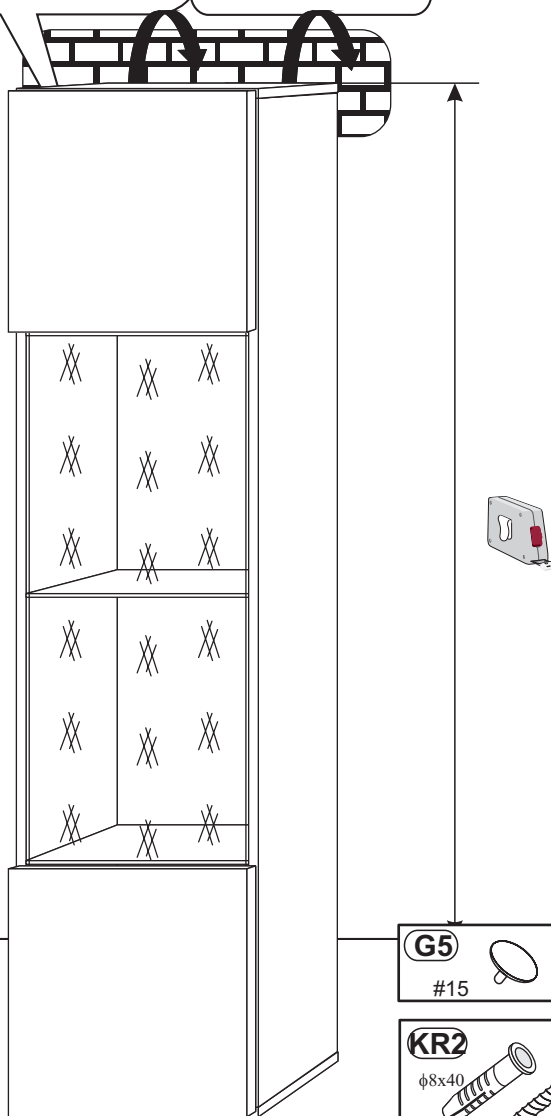

Verstellmöglichkeiten

- a) Fugenverstellung:
Befestigungsschraube "A" lockern, gewünschte Fuge mit Schraube "B" einstellen, Schraube "A" anziehen.
- b) Tiefenverstellung:
Befestigungsschraube "A" lockern, Bandarm nach vorne oder rückwärts verschieben, Schraube "A" anziehen, Schraube "B" mit einer 1/4 Drehung nach rechts arretieren.
- c) Höhenverstellung:
Befestigungsschraube "C" lockern, Höhe einstellen, Schraube "C" anziehen.

Instructions for hinge adjustment

- a) Side adjustment:
Loosen fixing screw "A", adjust gap with screw "B" and retighten screw "A".
- b) Depth adjustment:
Loosen fixing screw "A", push hinge arm forwards or backwards, retighten screw "A", fix screw "B" with a 1/4-turn in clock-wise direction.
- c) Height adjustment:
Loosen screw "C", adjust height, retighten screw "C".

Les possibilités de positionnement

- a) Positionnement de la rainure:
Desserrer la vis de fixation "A", positionner avec la vis "B" la rainure (joint) souhaitée et resserrer la vis "A".
- b) Positionnement de la profondeur:
Desserrer la vis de fixation "A" (1 tour), régler la profondeur et resserrer la vis "A".
- c) Positionnement de la hauteur:
Desserrer la vis de fixation "C" (1 tour), positionner la hauteur et resserrer la vis "C".

Możliwości regulacji

- a) Regulacja szczeliny:
Poluzować wkręt "A", wkrętem "B" ustawić odpowiednią szczelinę, dokręcić wkręt "A".
- b) Regulacja głębokości:
Poluzować wkręt "A" (1 obrót), ustawić głębokość, dokręcić wkręt "A".
- c) Regulacja wysokości:
Poluzować wkręt "C" (1 obrót), dokonać regulacji wysokości położenia drzwi, wkręt "C" dokręcić.

