

# MONTAGEANLEITUNG INSTRUKCJA MONTAŻOWA

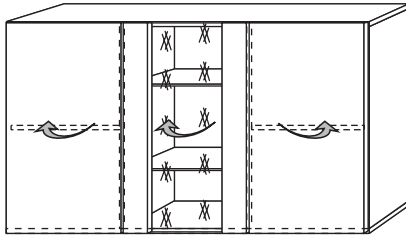

Typ:L



Typ:P

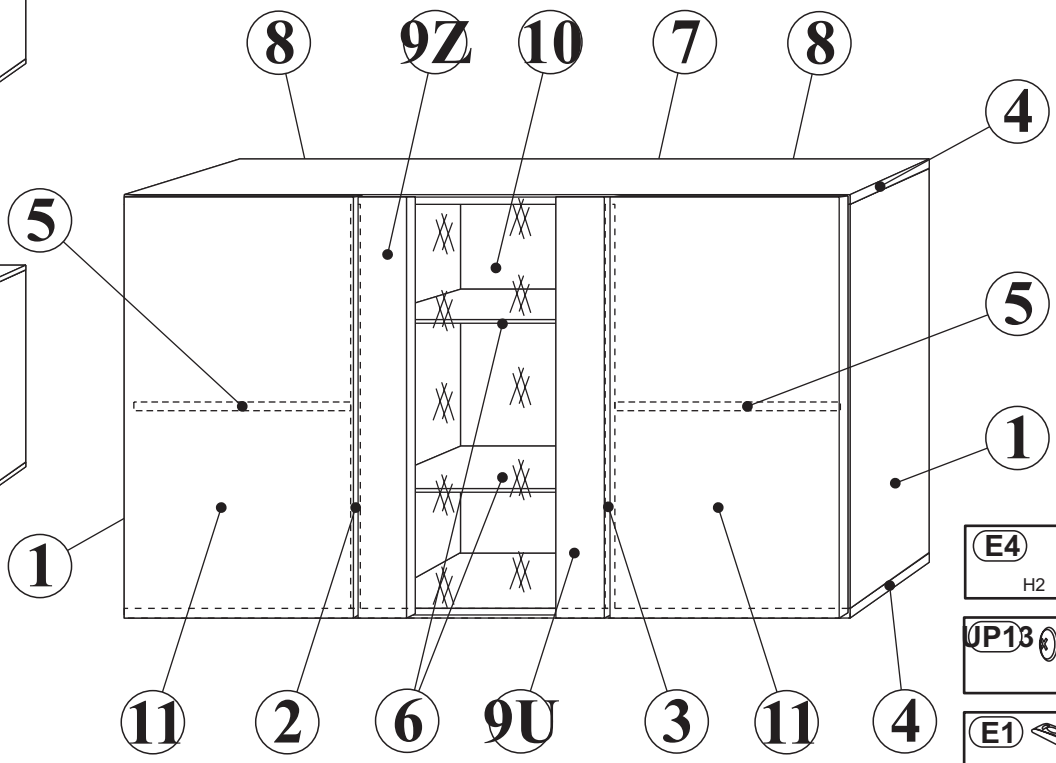
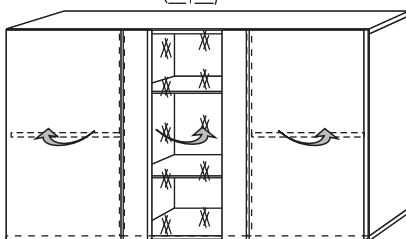

**2 Personen  
2 Osoby**

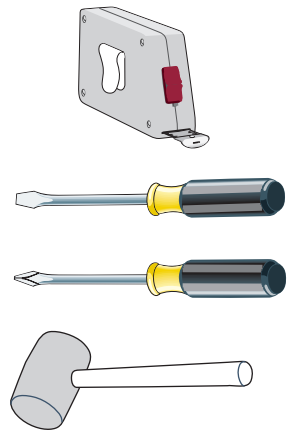

- |                          |                          |
|--------------------------|--------------------------|
| <b>G2</b><br>S-4 x1      | <b>A1</b><br>φ 8x36 x16  |
| <b>AM</b><br>x3          | <b>B5</b><br>x16         |
| <b>B4</b><br>x16         | <b>G5</b><br>#15 x116    |
| <b>G4</b><br>φ 5 x4      | <b>G20</b><br>x8         |
| <b>G7</b><br>x8          | <b>P1</b><br>x8          |
| <b>E4</b><br>H2 x2       | <b>S1</b><br>x10         |
| <b>UP13</b><br>3x16 x8   | <b>D9</b><br>3x20 x10    |
| <b>E1</b><br>Kr0 x4      | <b>G16</b><br>x10        |
| <b>E3</b><br>Kr8 x2      | <b>D10</b><br>3,5x13 x18 |
| <b>KR2</b><br>φ8x40 x4   | <b>E2</b><br>H0 x4       |
| <b>E2</b><br>H0 x4       | <b>ZR1</b><br>x4         |
| <b>EK2</b><br>6,3x13 x12 | <b>D6</b><br>3,5x30 x8   |

1

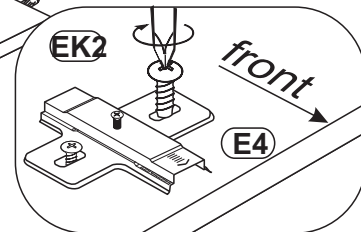
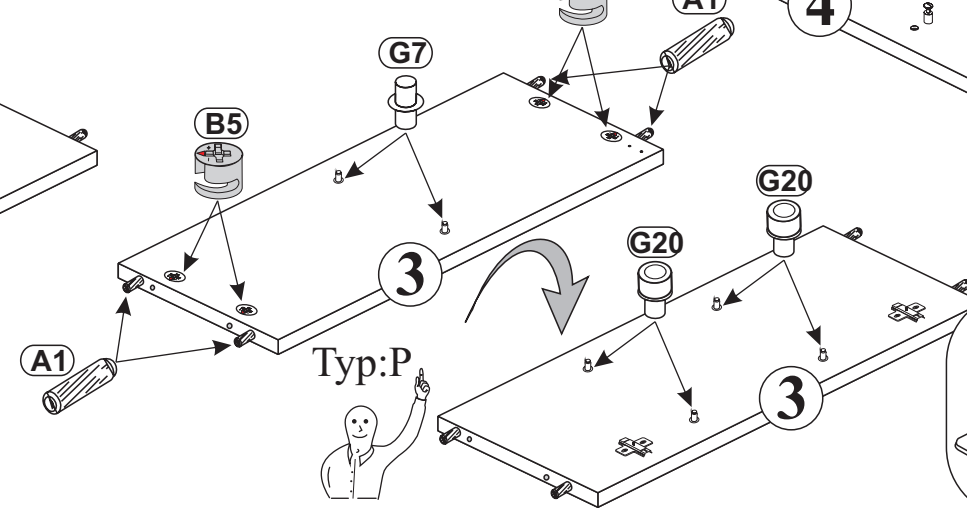
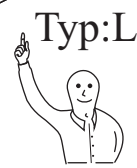
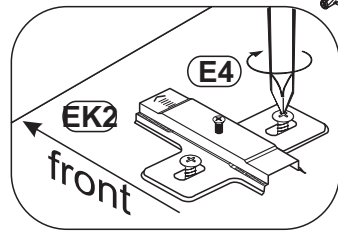
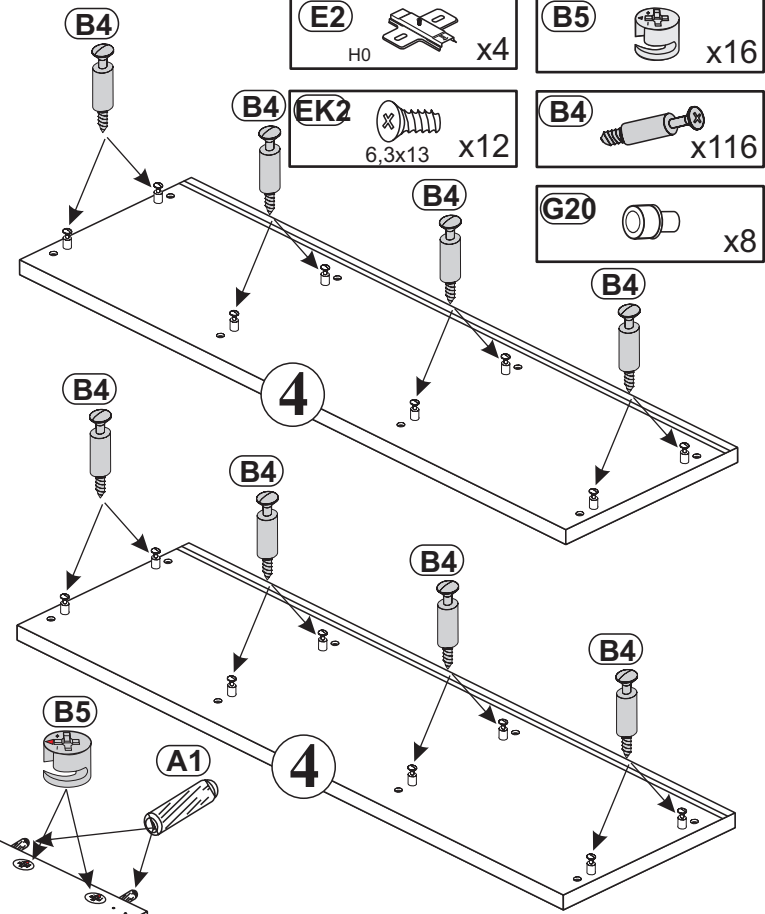
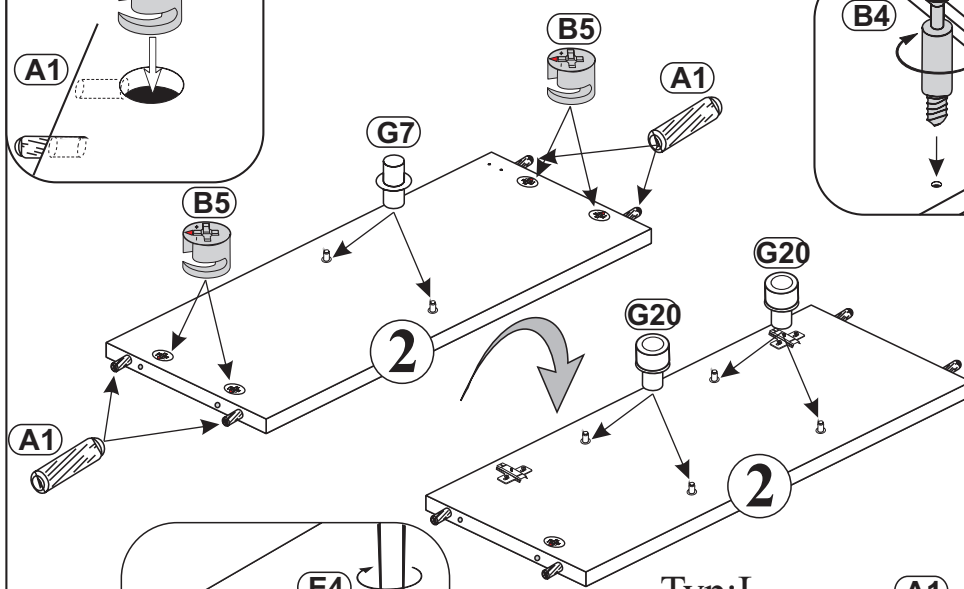
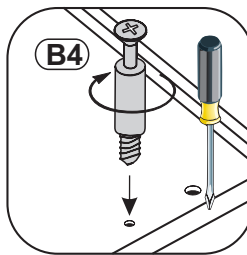
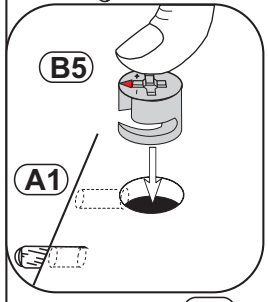
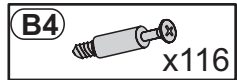
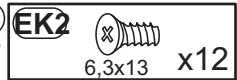
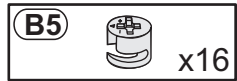
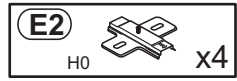
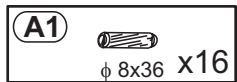
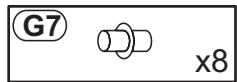
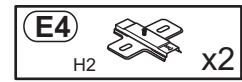
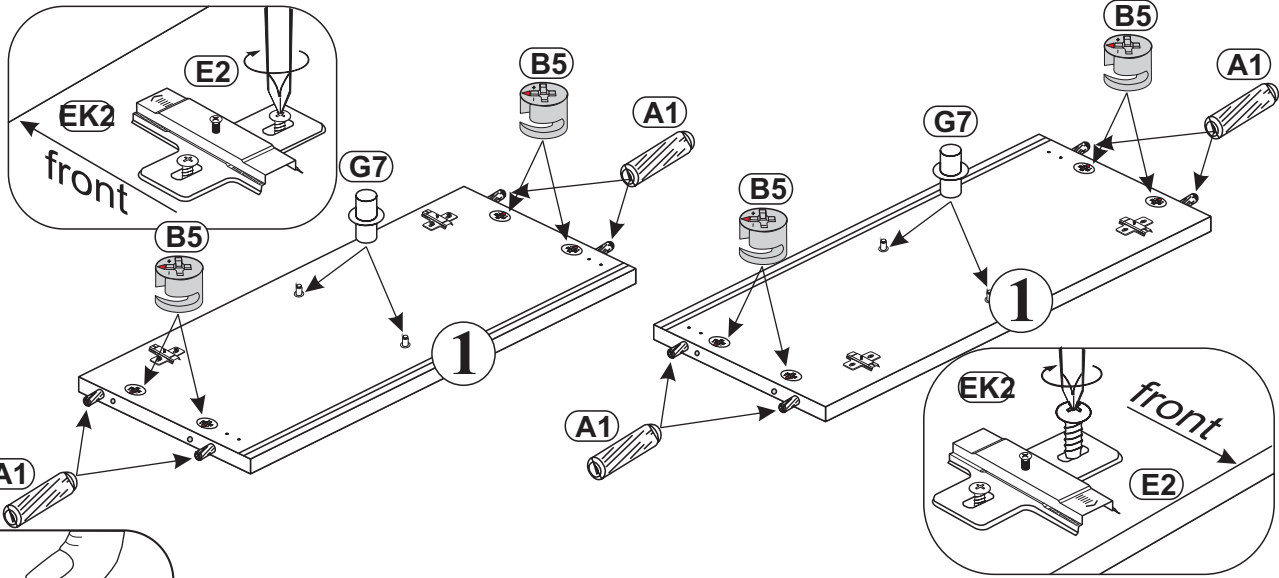

# 2

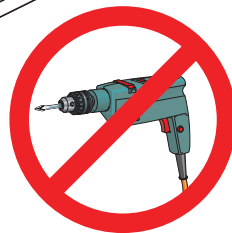
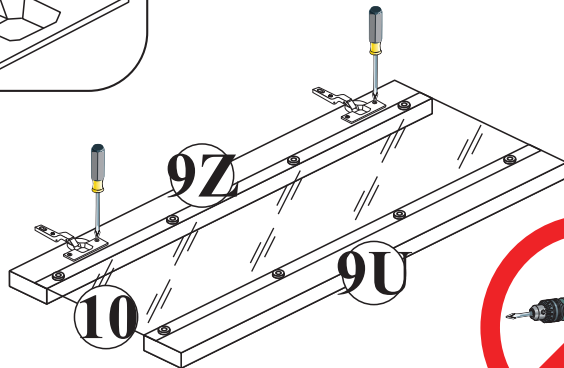
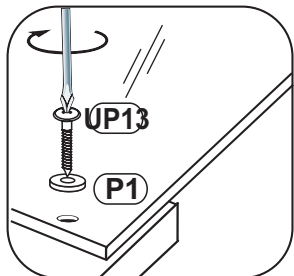
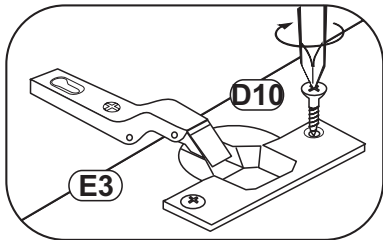
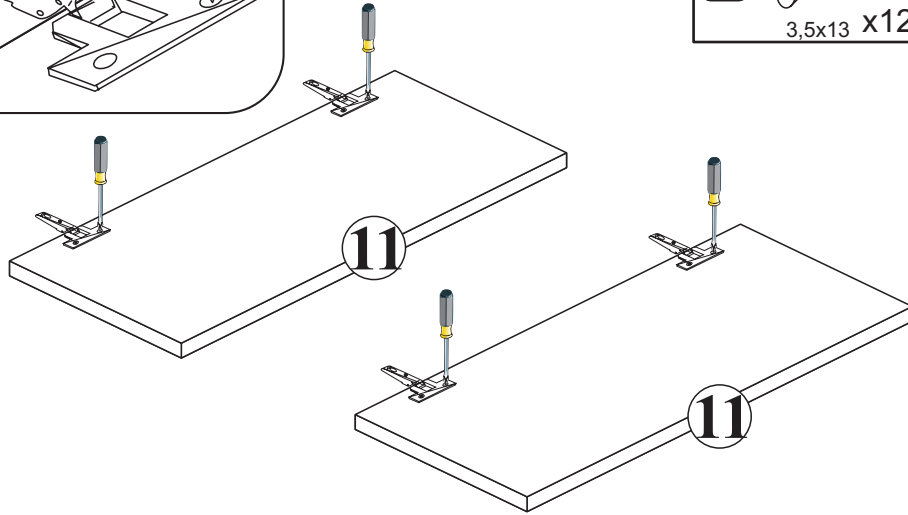
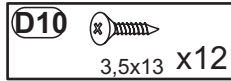
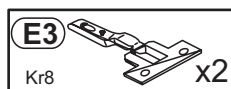
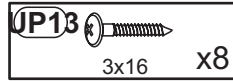
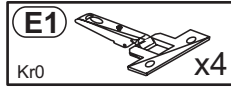
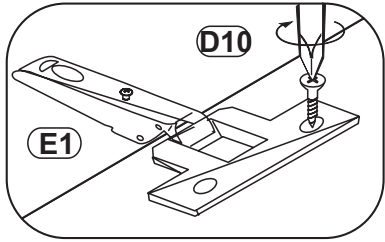

# 3

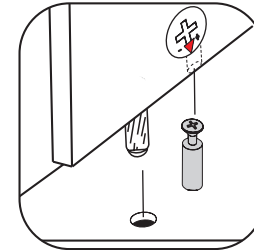
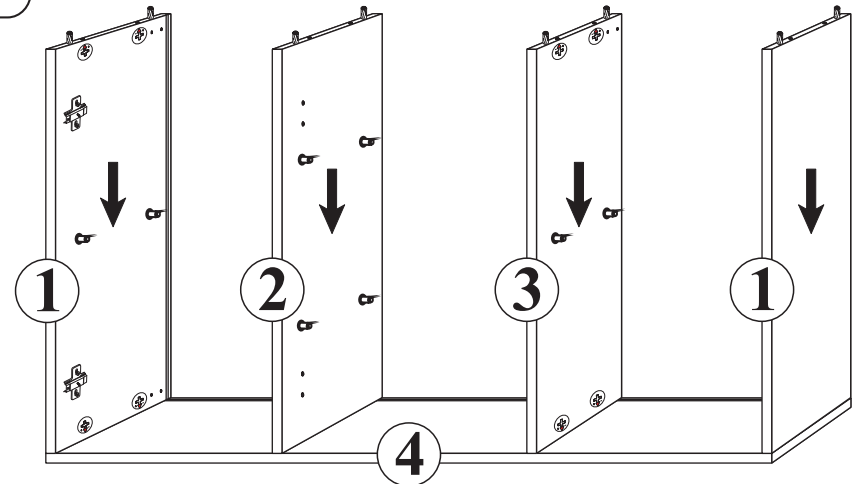
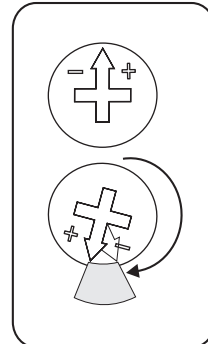
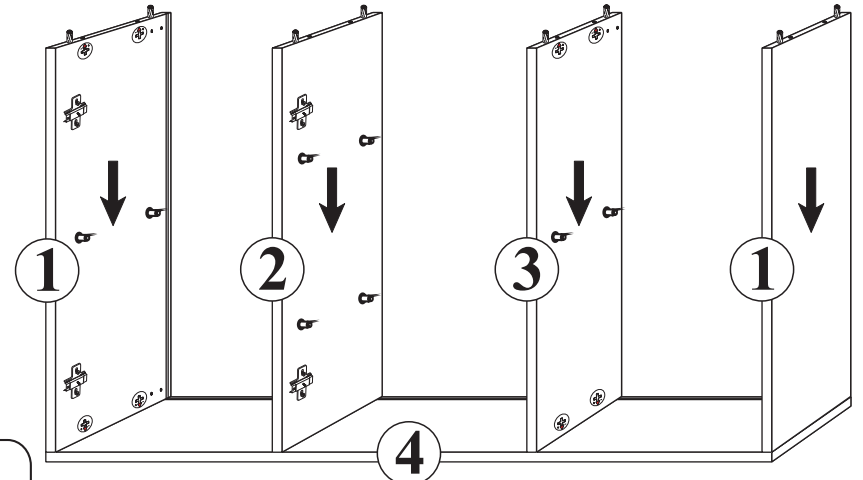
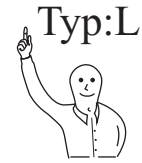

# 4

Typ:L

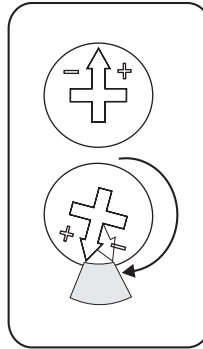
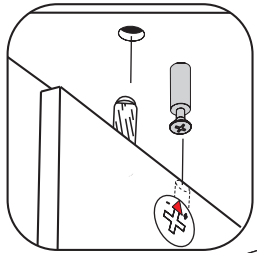
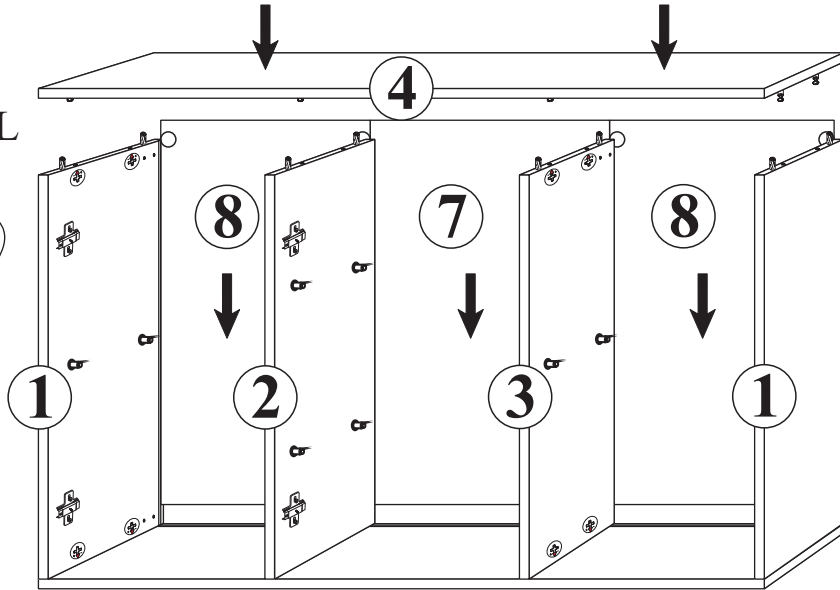

Typ:P

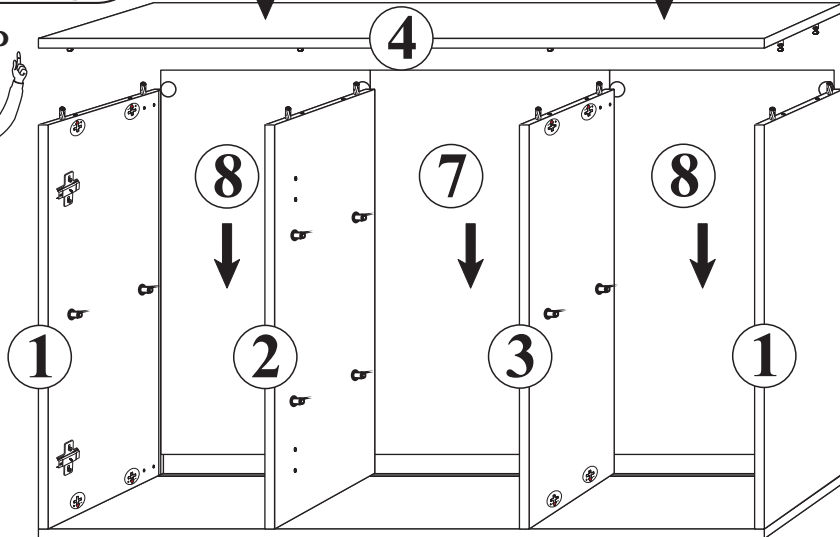

# 5

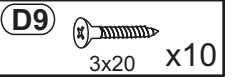

a=b

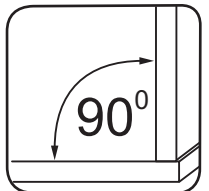
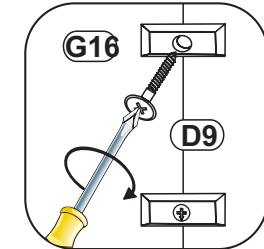
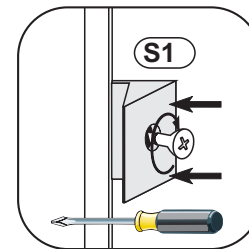
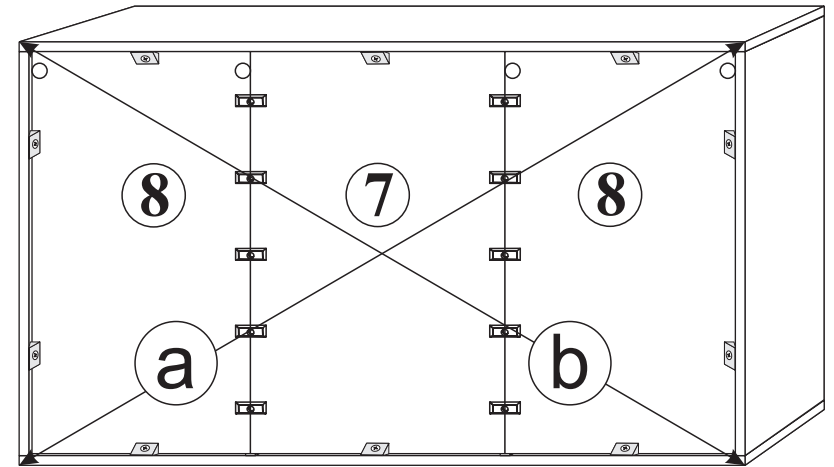

6

Typ:L  

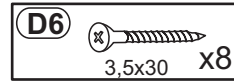
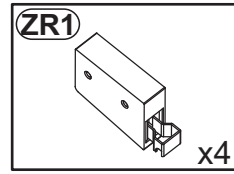
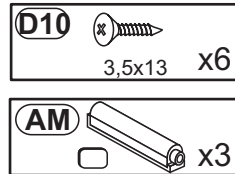
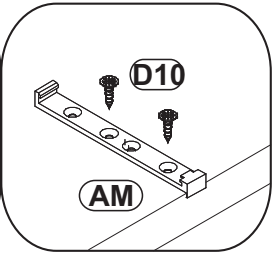
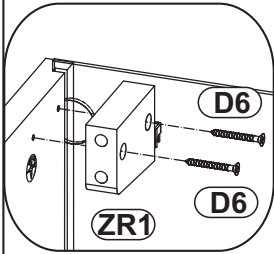
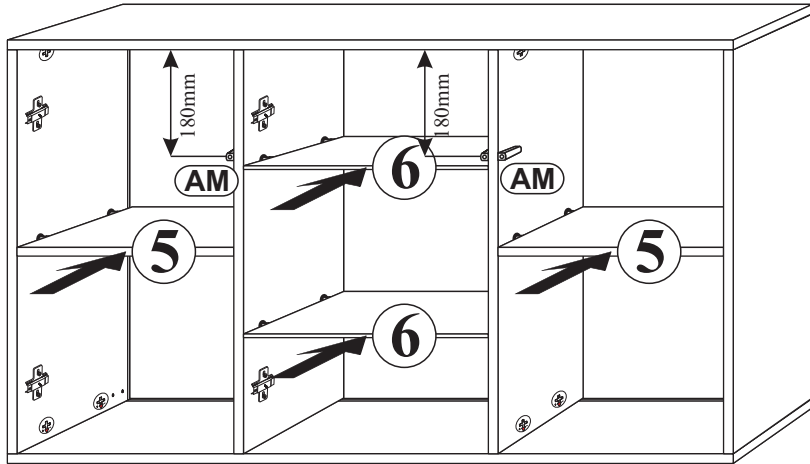

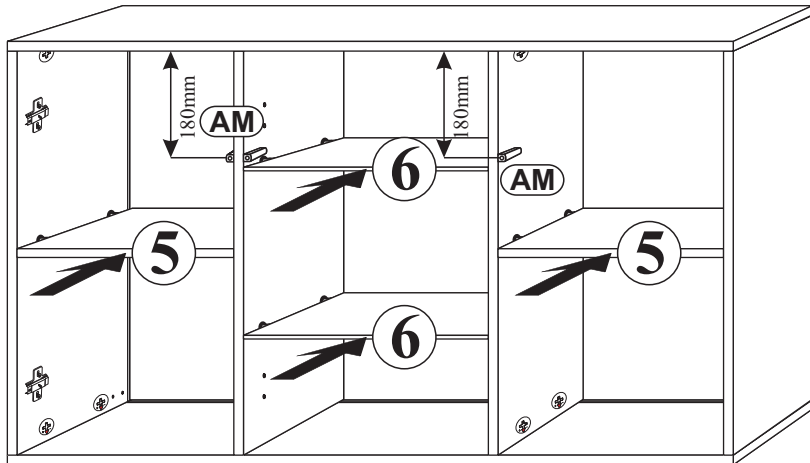

Typ:P  



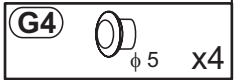
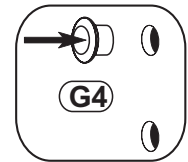
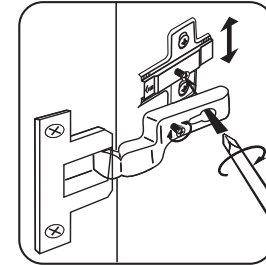
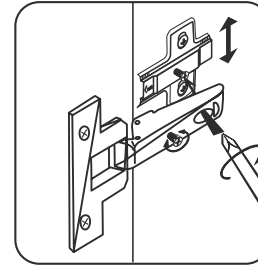
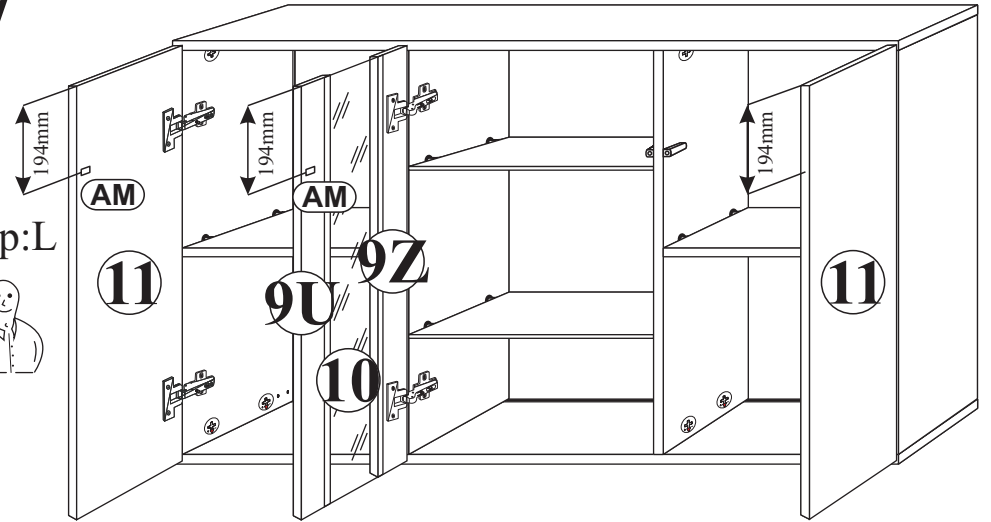

7

Typ:L  

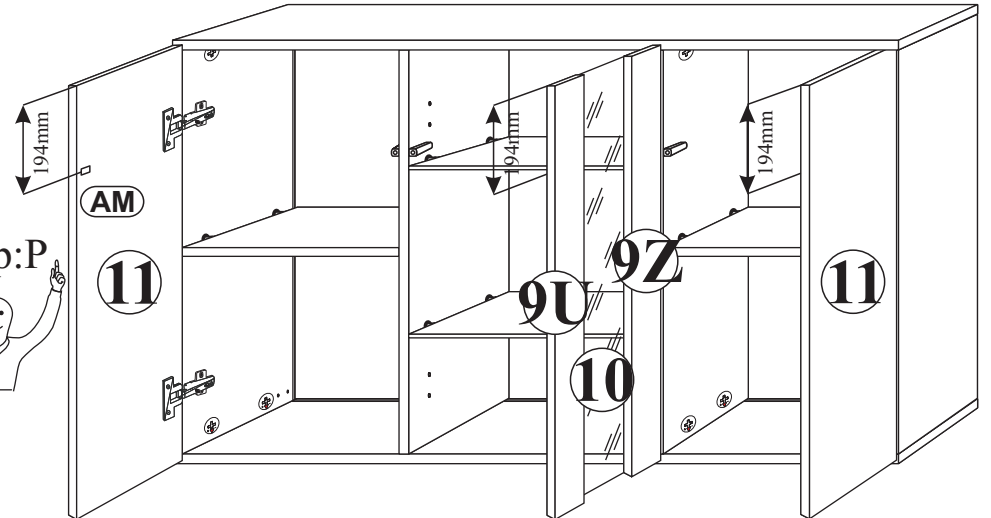

Typ:P  

# 8

**G5**  
#15 x16

**KR2**  
φ8x40 x4

