

Monica

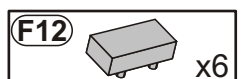

1

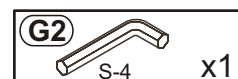
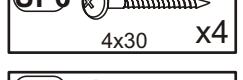
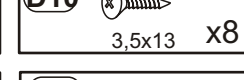
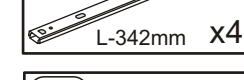
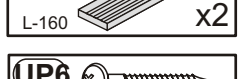
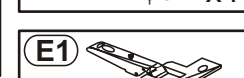
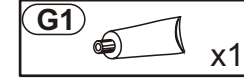
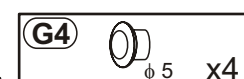
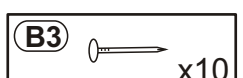
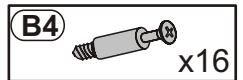
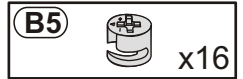
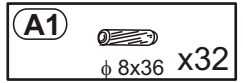
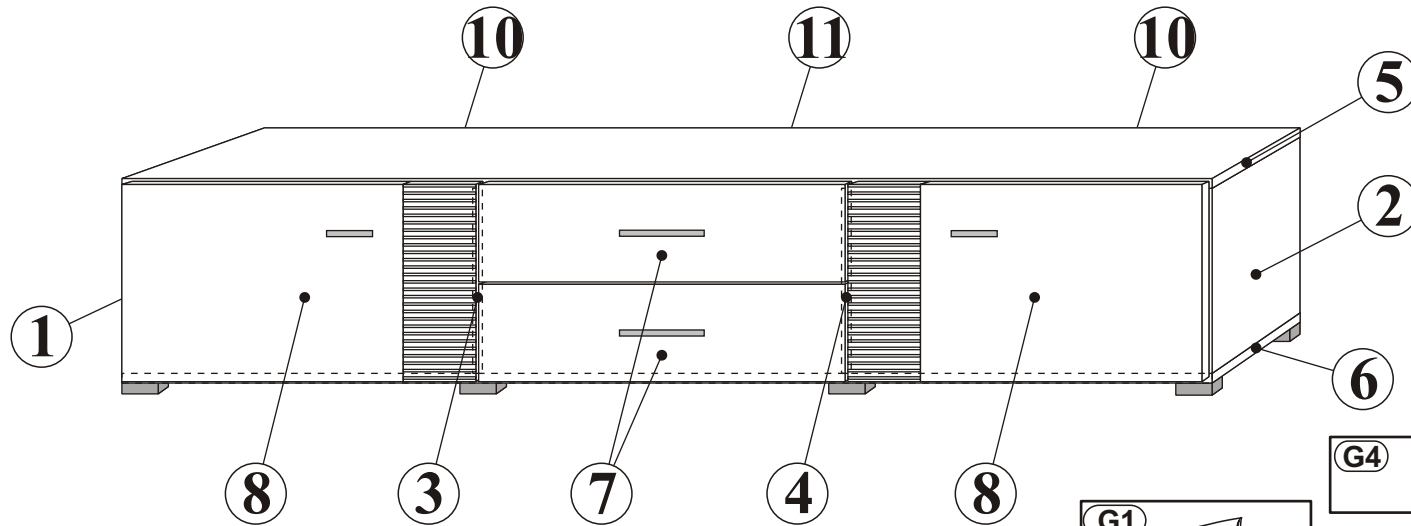
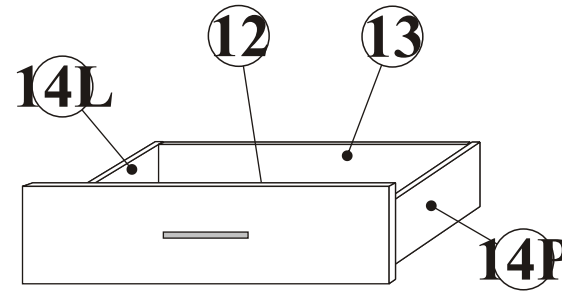
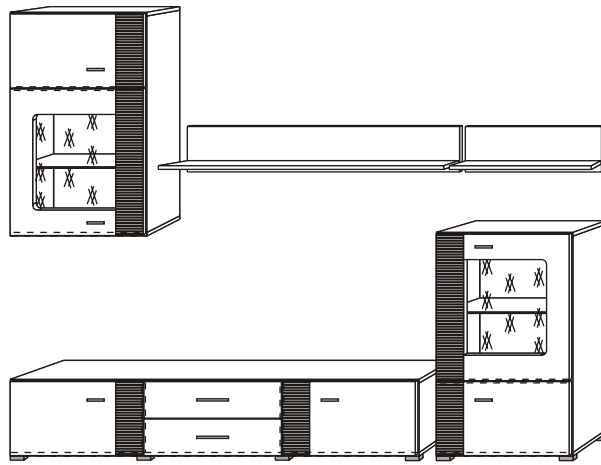
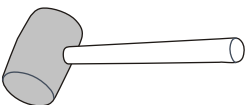
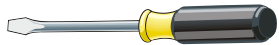
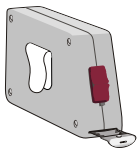
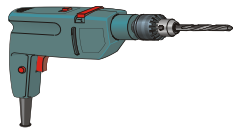
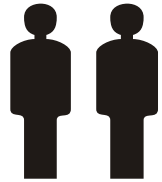
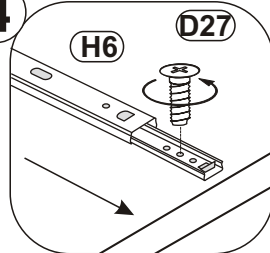
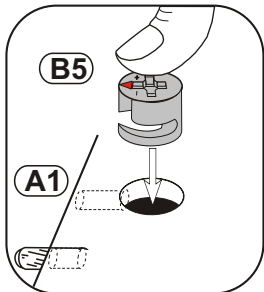
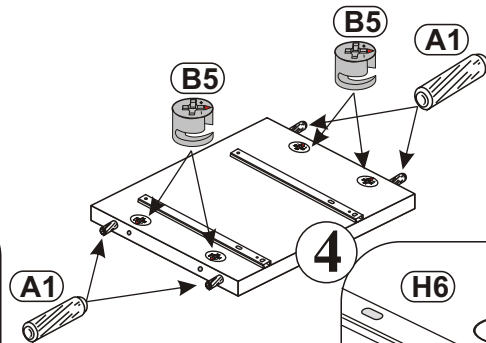
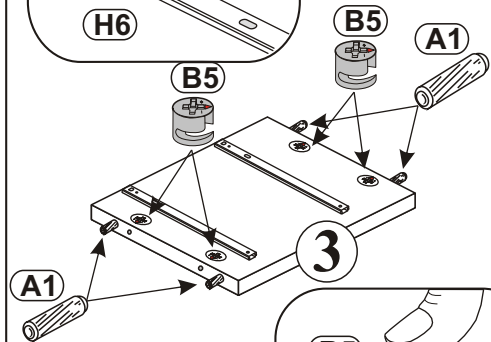
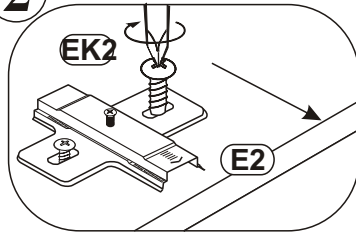
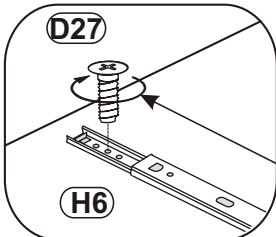
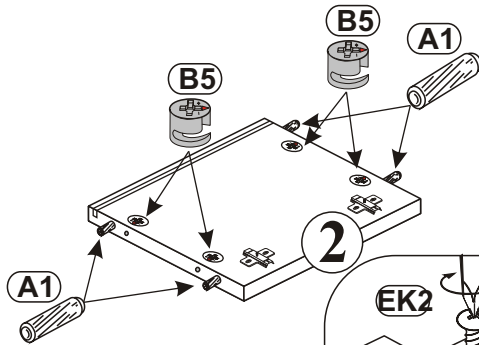
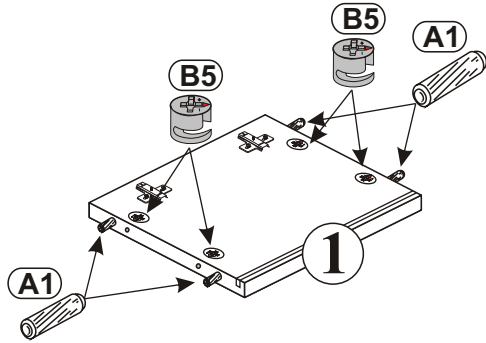
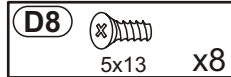
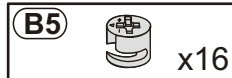
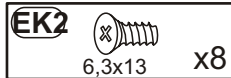
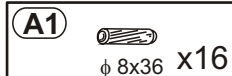
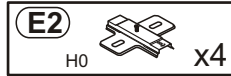
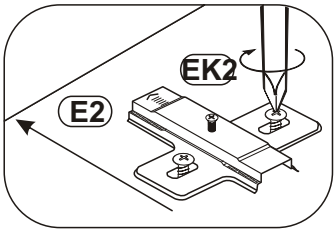

2

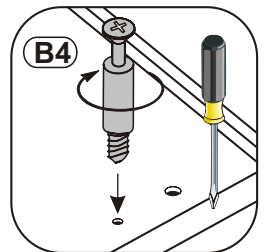
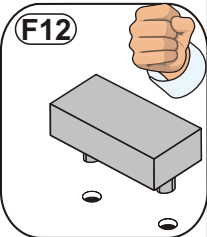
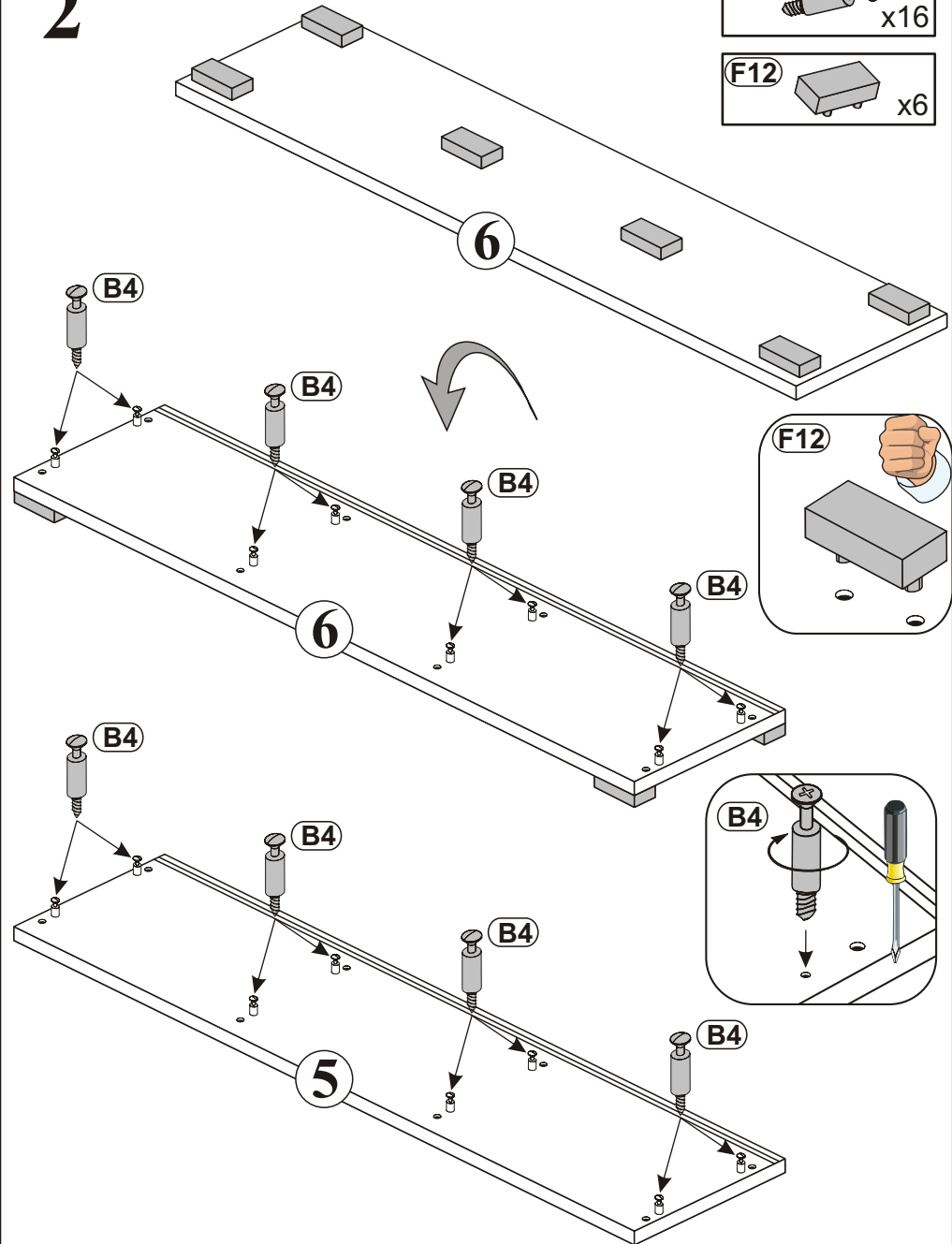
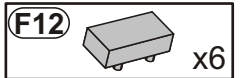
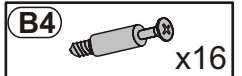

3

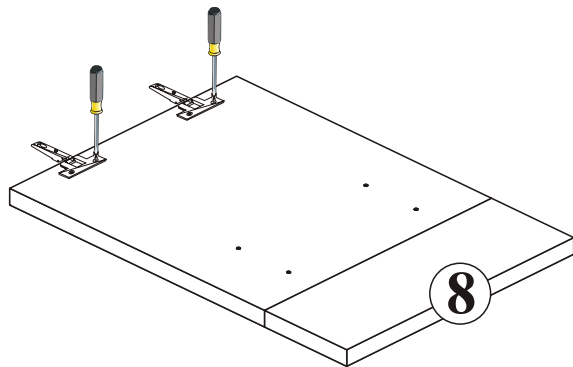
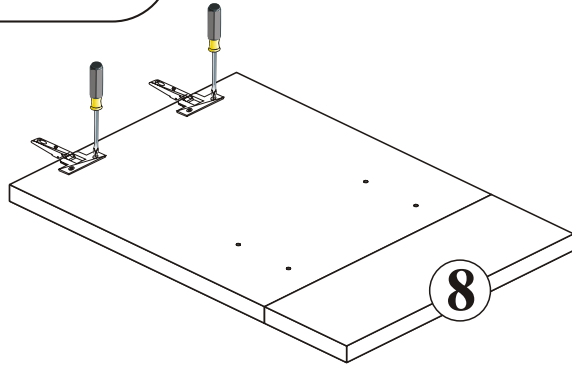
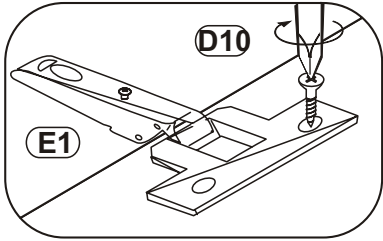
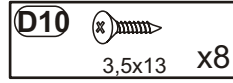
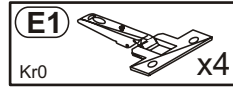

4

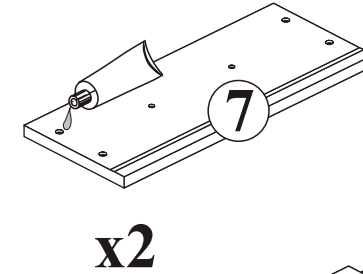
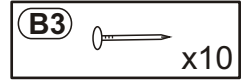
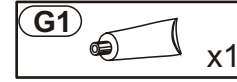
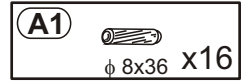
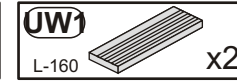
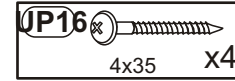

x2

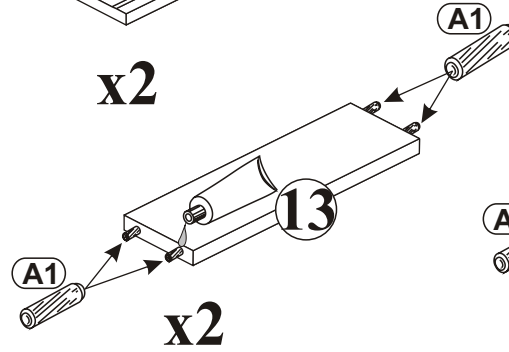

x2

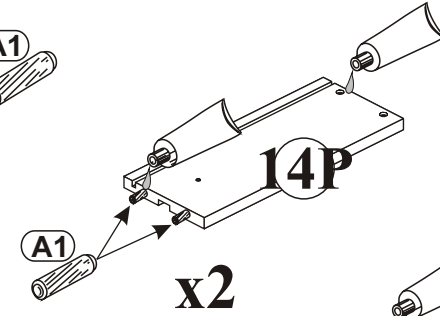

x2

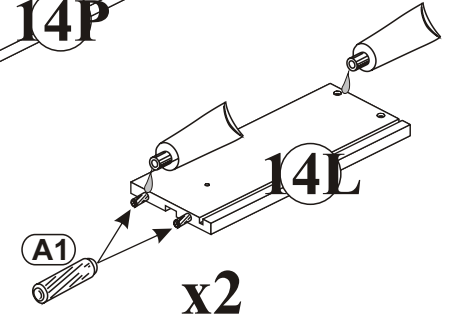

x2

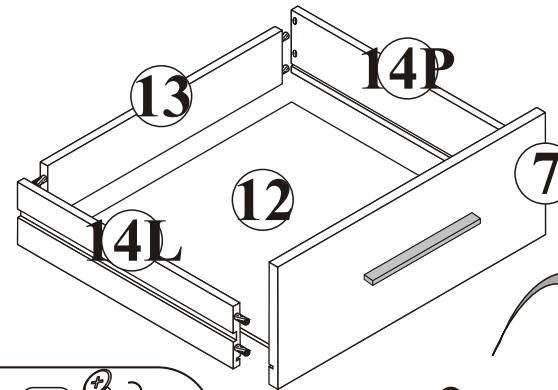

x2

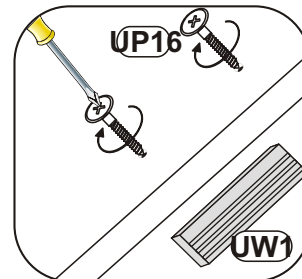

G3

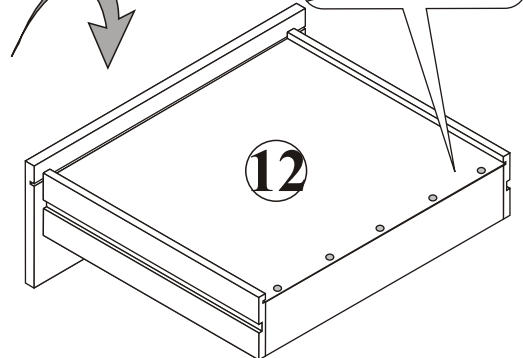

5

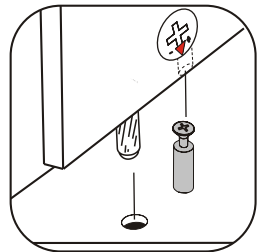
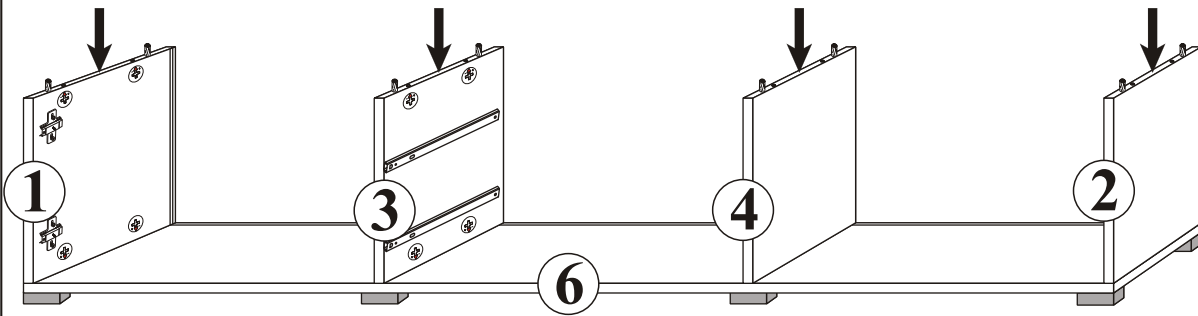

6

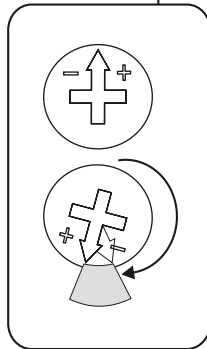
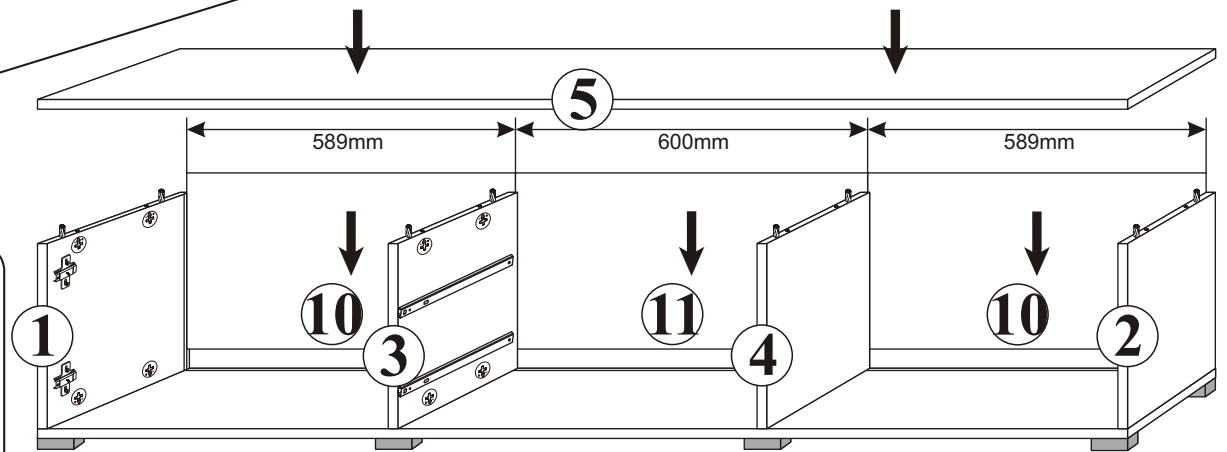
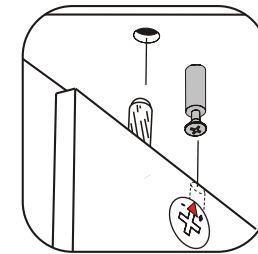

7

a=b

S1  x14

D9  3x20 x4

G16  x4

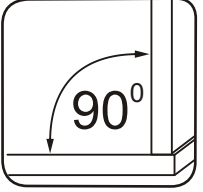
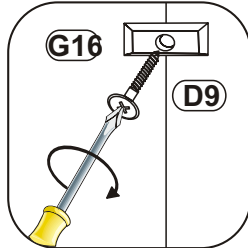
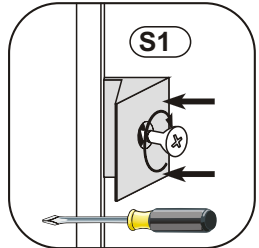
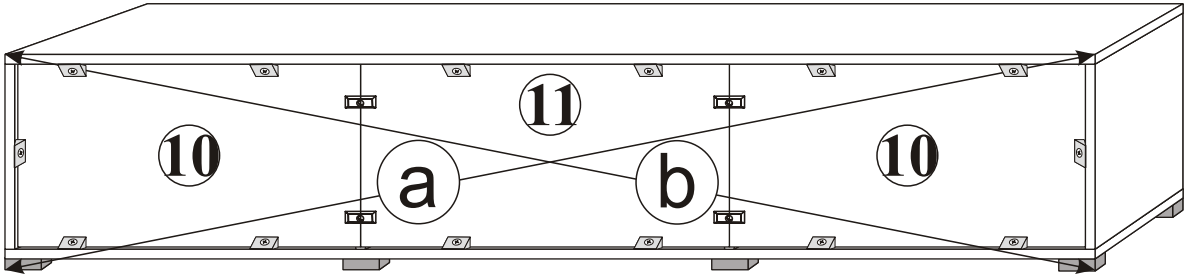

8

UW  L-64 x2

UP6  4x30 x4

G5  #15 x16

G4  φ5 x4

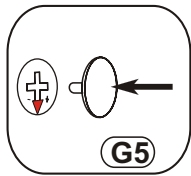
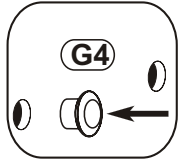
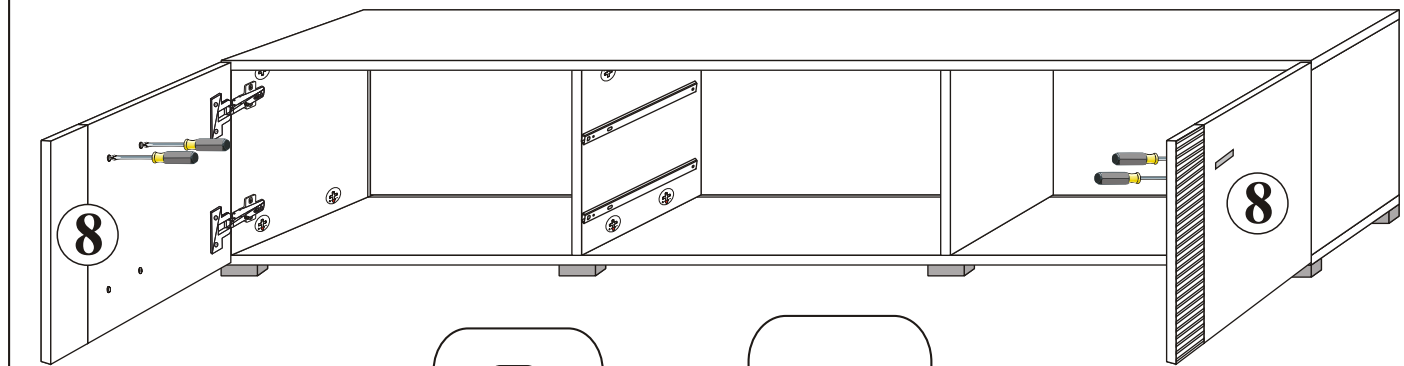
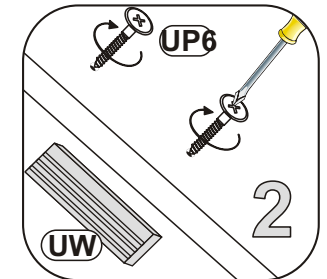
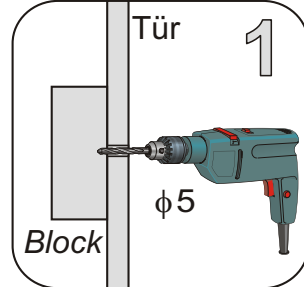
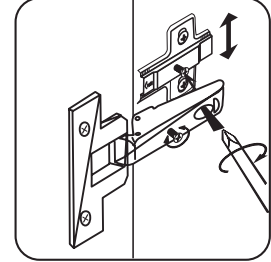

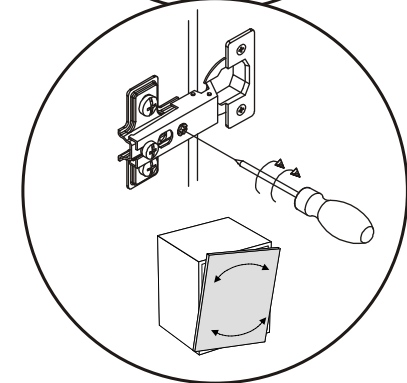
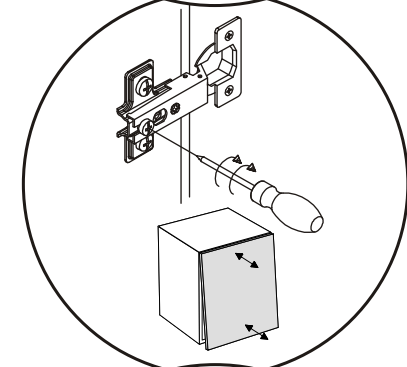
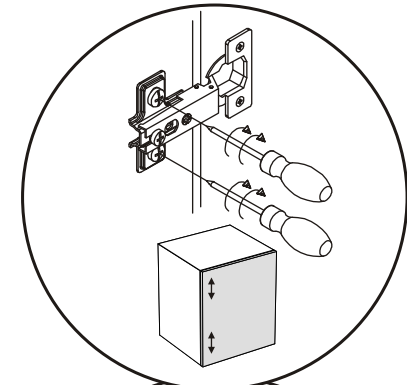
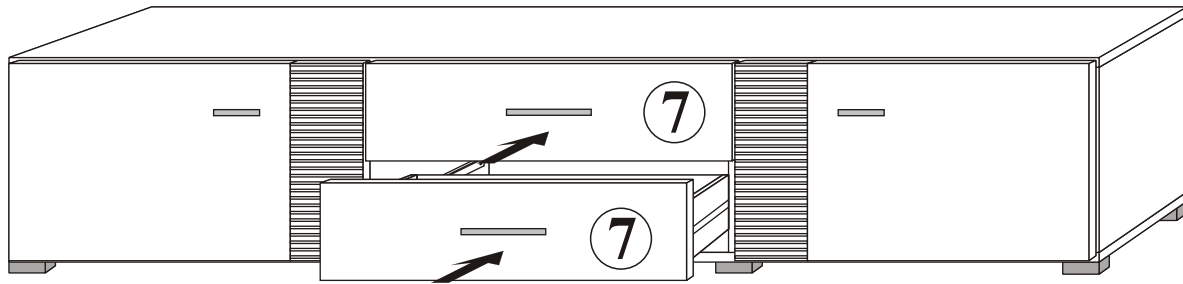
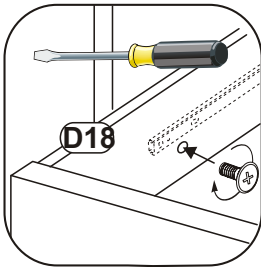

9

D18
M4x9mm x4

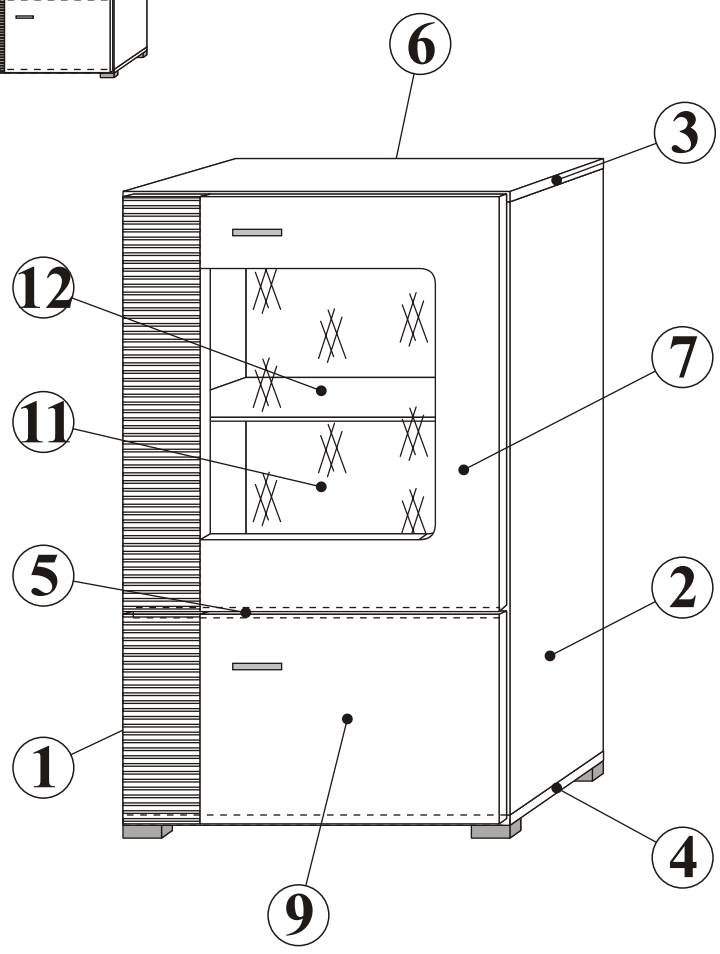
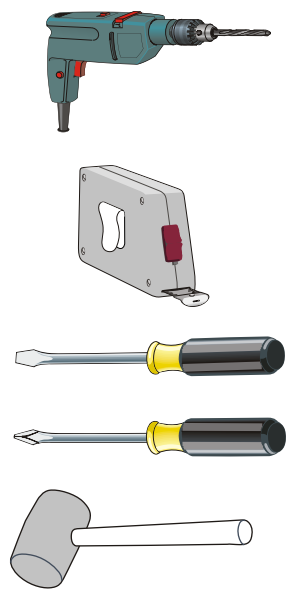
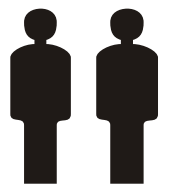
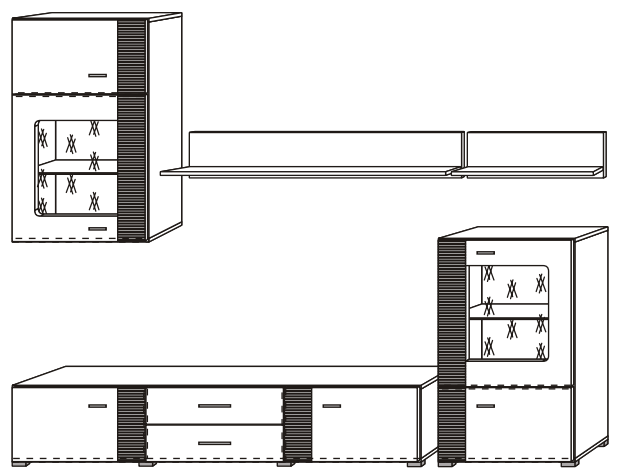



A1  x12
φ 8x36

B5  x12

B4  x12

G5  x12
#15

G20  x4

S1  x10

G4  φ 5 x12

UW  x2
L-64

P1  x4

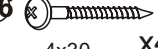
UP6  x4
4x30

UP13  x4
3x16

F12  x4

E1  x4
Kr0

L1  x1

D10  x10
3,5x13

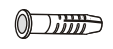
KR2  x1

E2  x4
H0

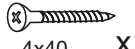
D22  x1
4x40

EK2  x8
6,3x13

G2  x1
S-4

1

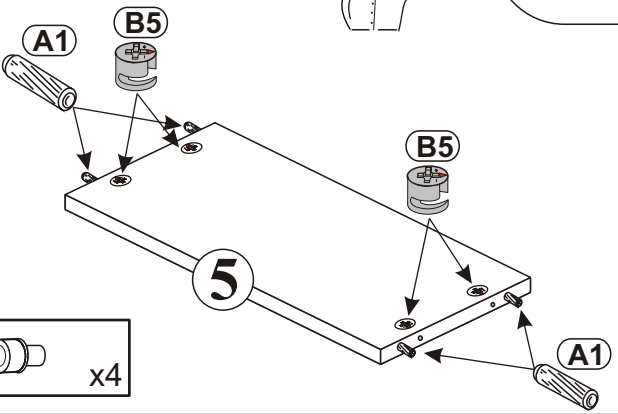
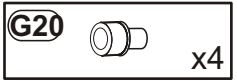
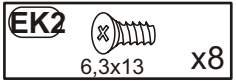
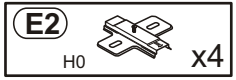
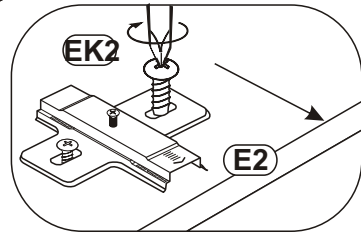
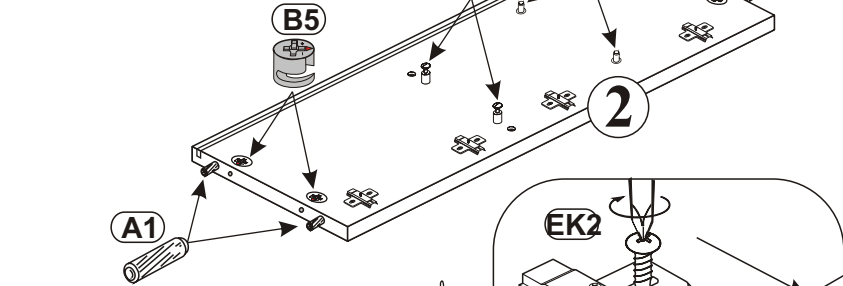
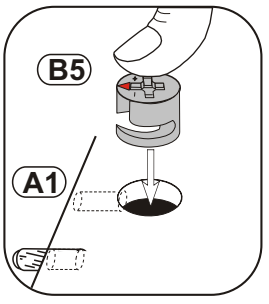
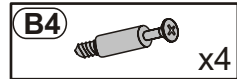
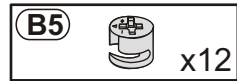
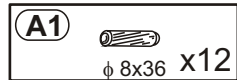
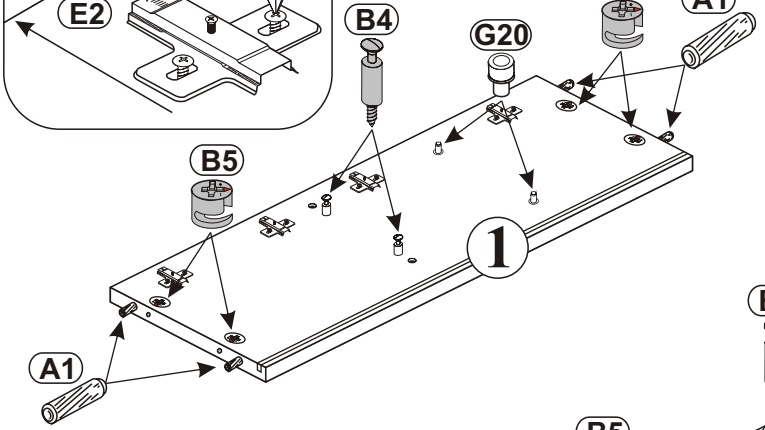
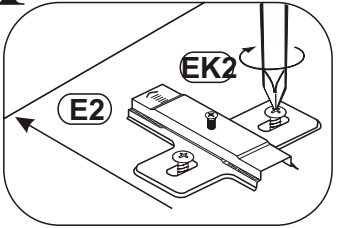

2

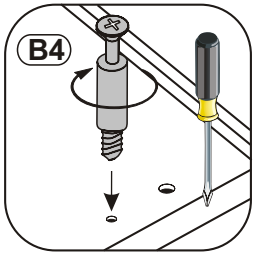
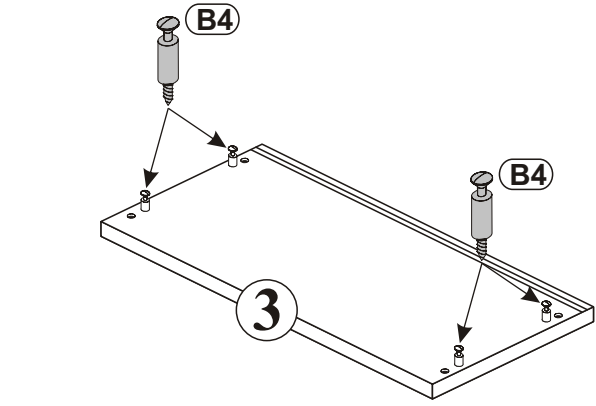
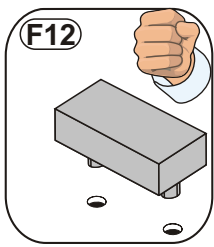
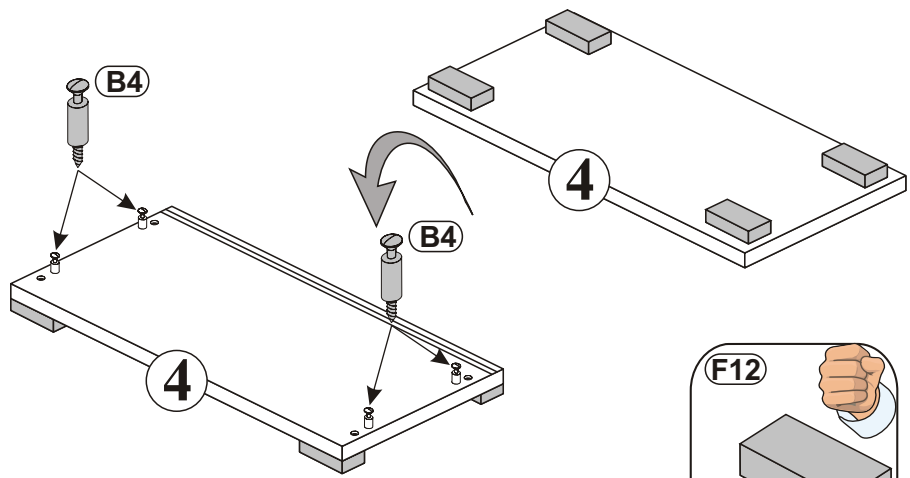
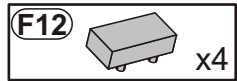
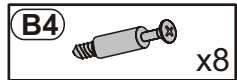

3

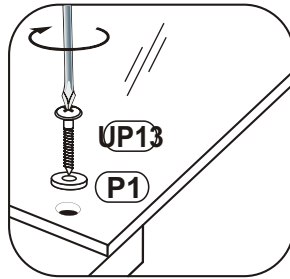
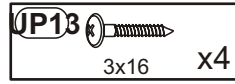
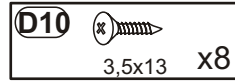
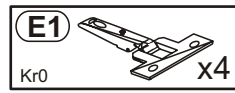
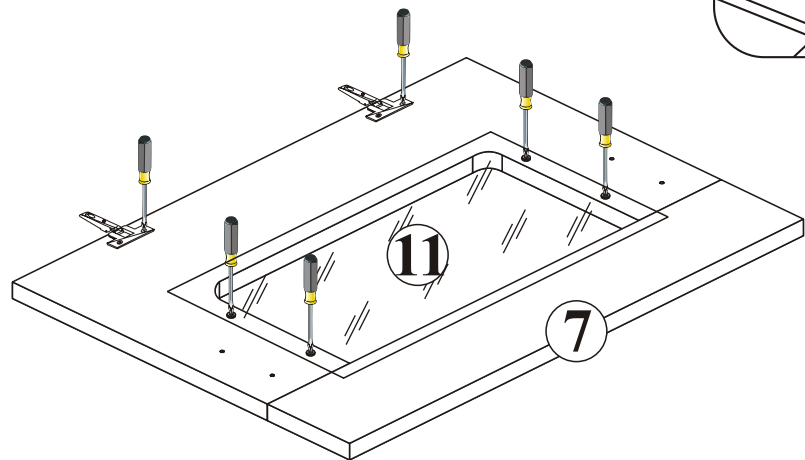
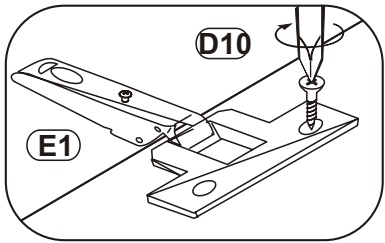
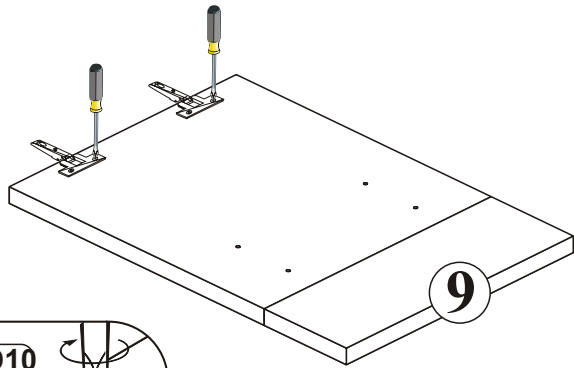

4

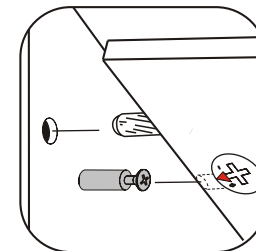
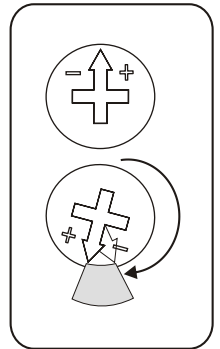
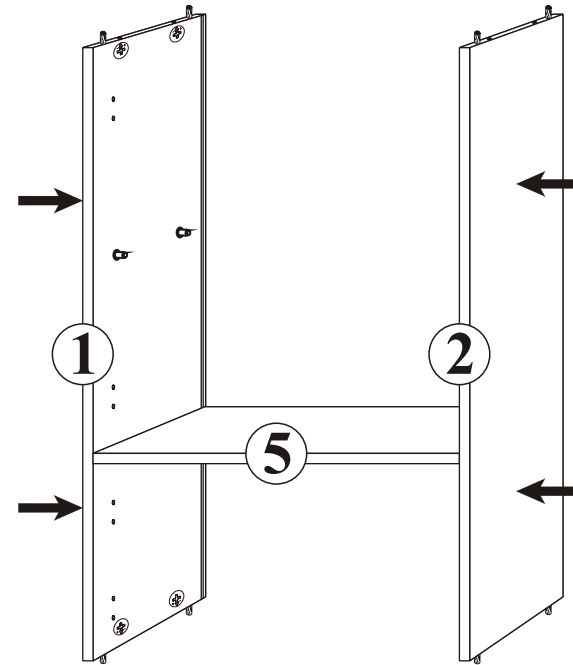

5

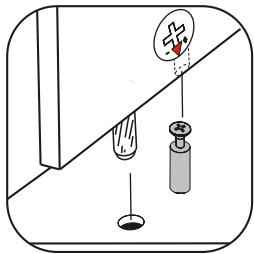
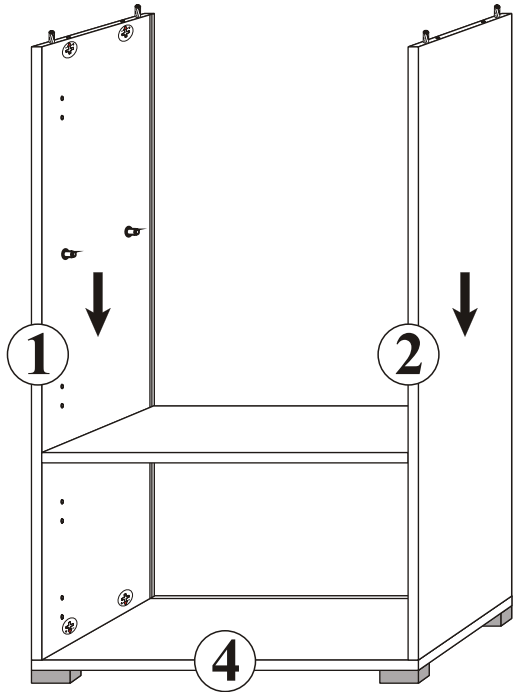

6

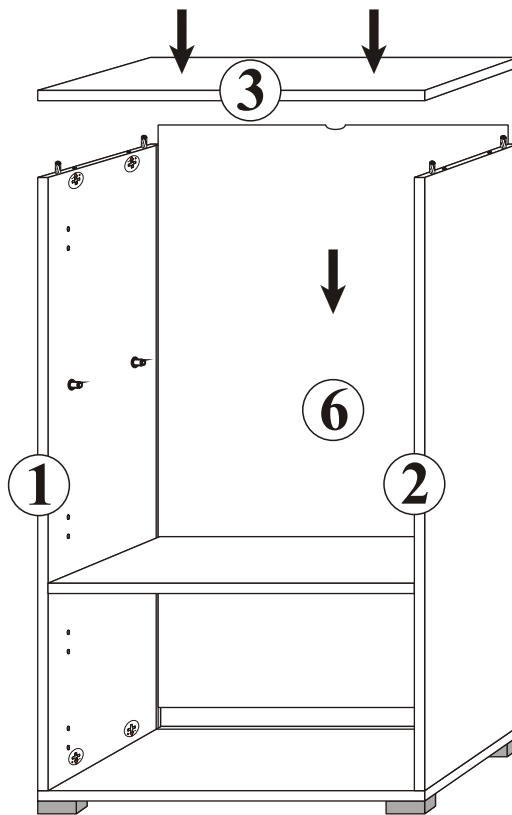
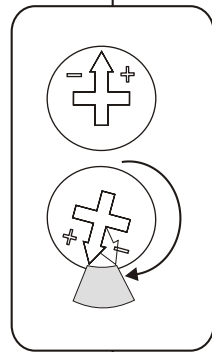
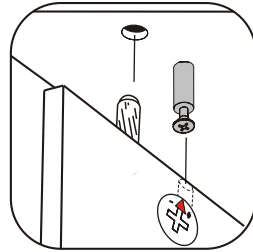

7

S1  x10

a=b

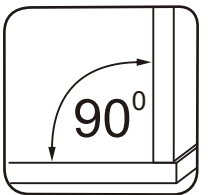
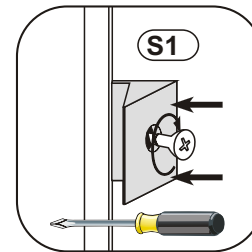
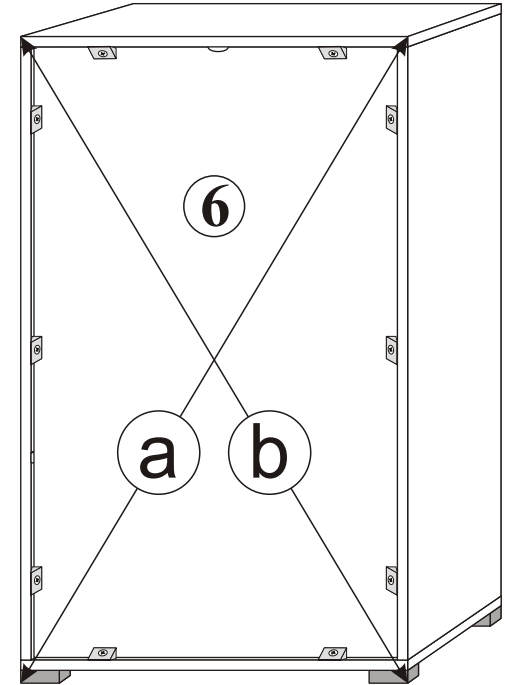

8

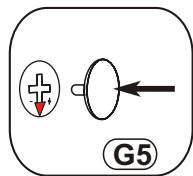
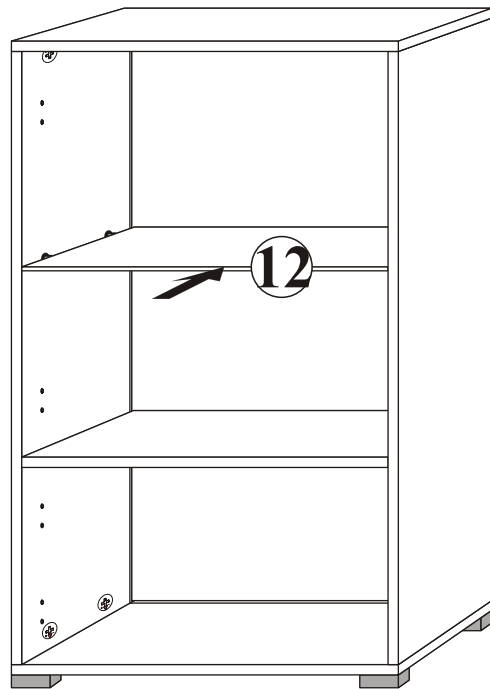

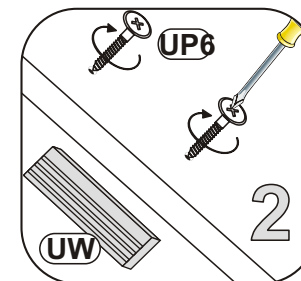
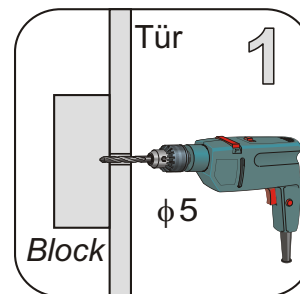
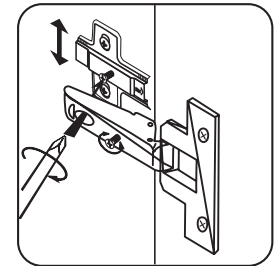
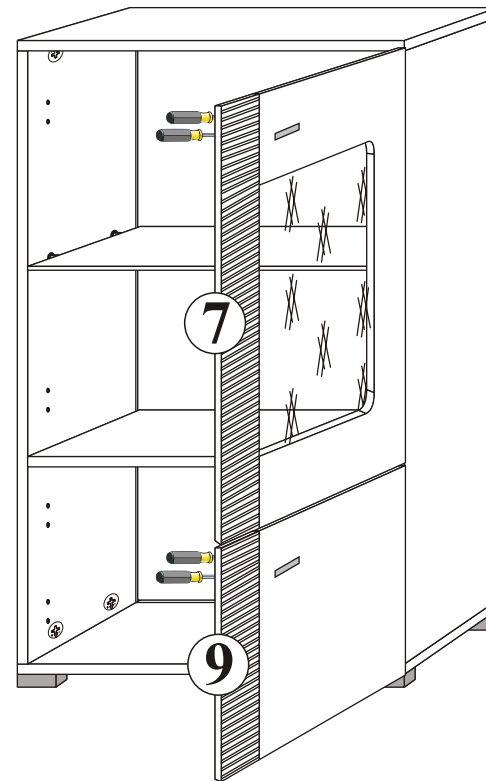
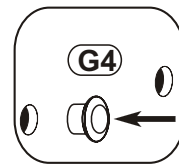
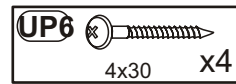
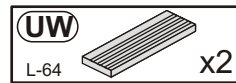

9



10

D10  3,5x13 x2

L1  x1

KR2  x1

D22  4x40 x1

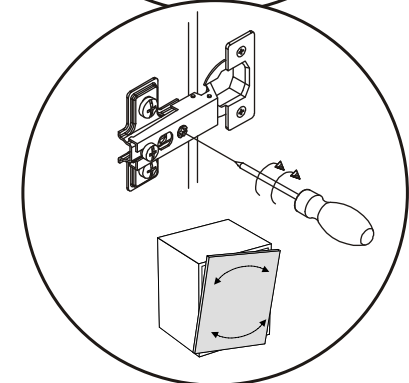
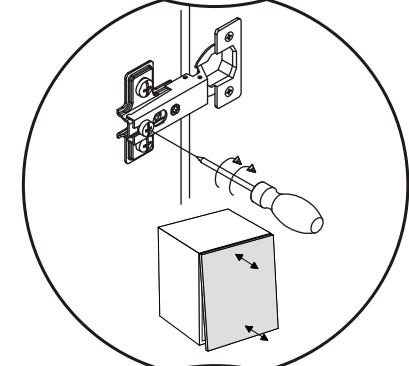
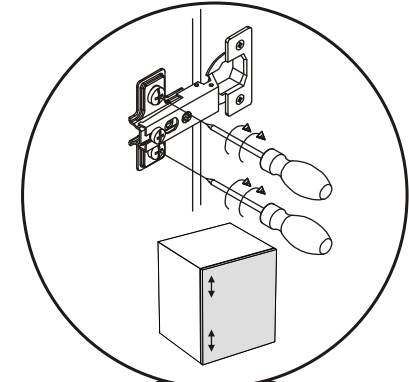
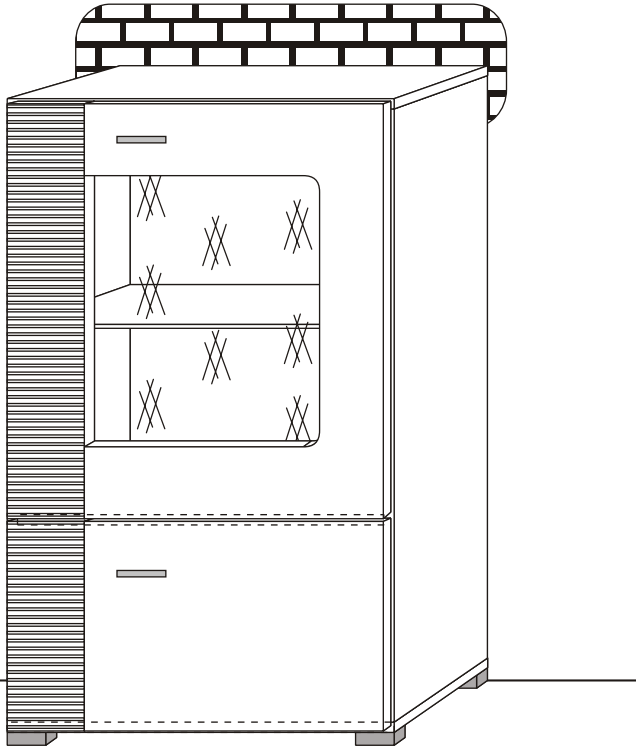
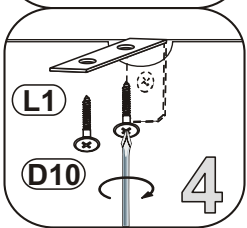
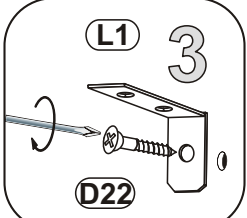
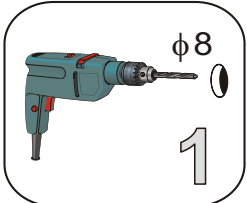

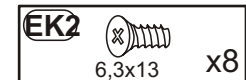
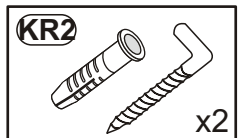
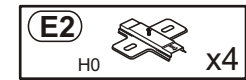
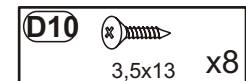
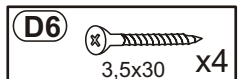
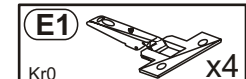
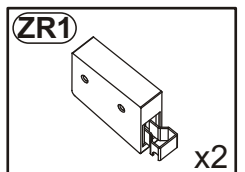
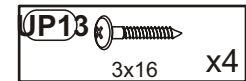
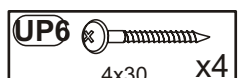
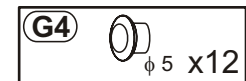
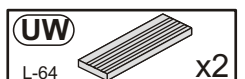
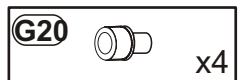
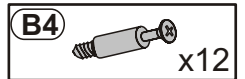
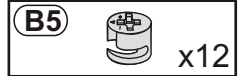
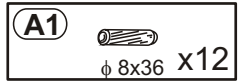
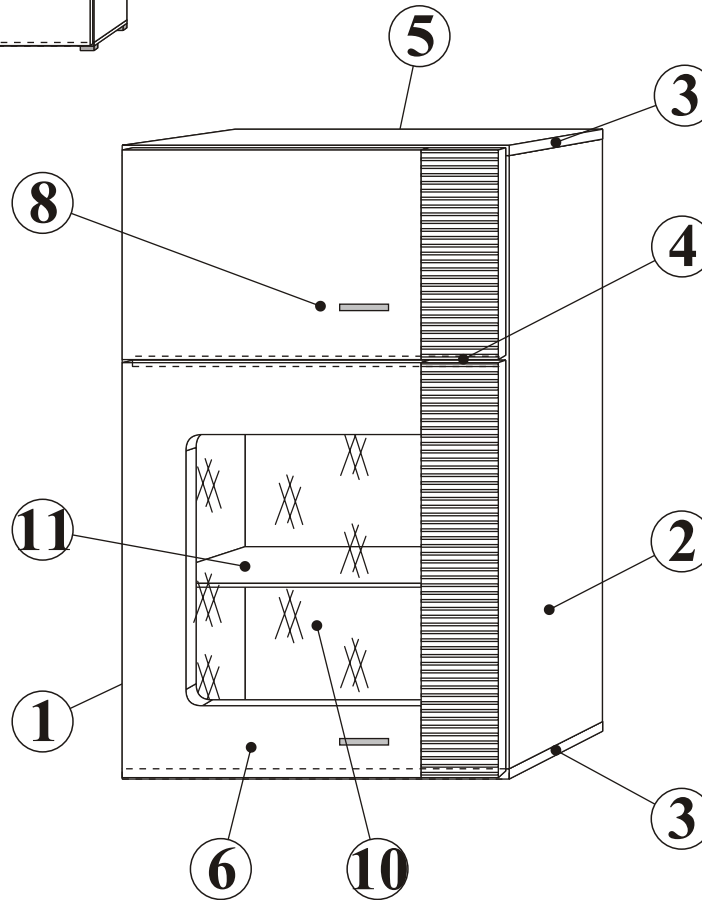
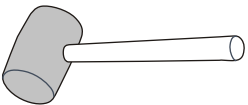
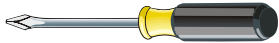
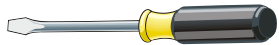
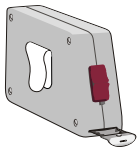
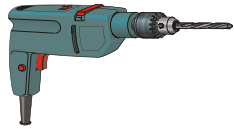
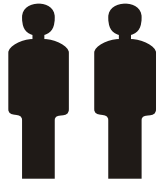
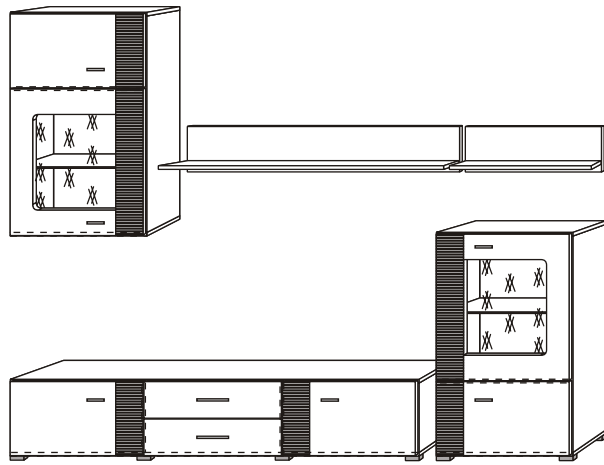

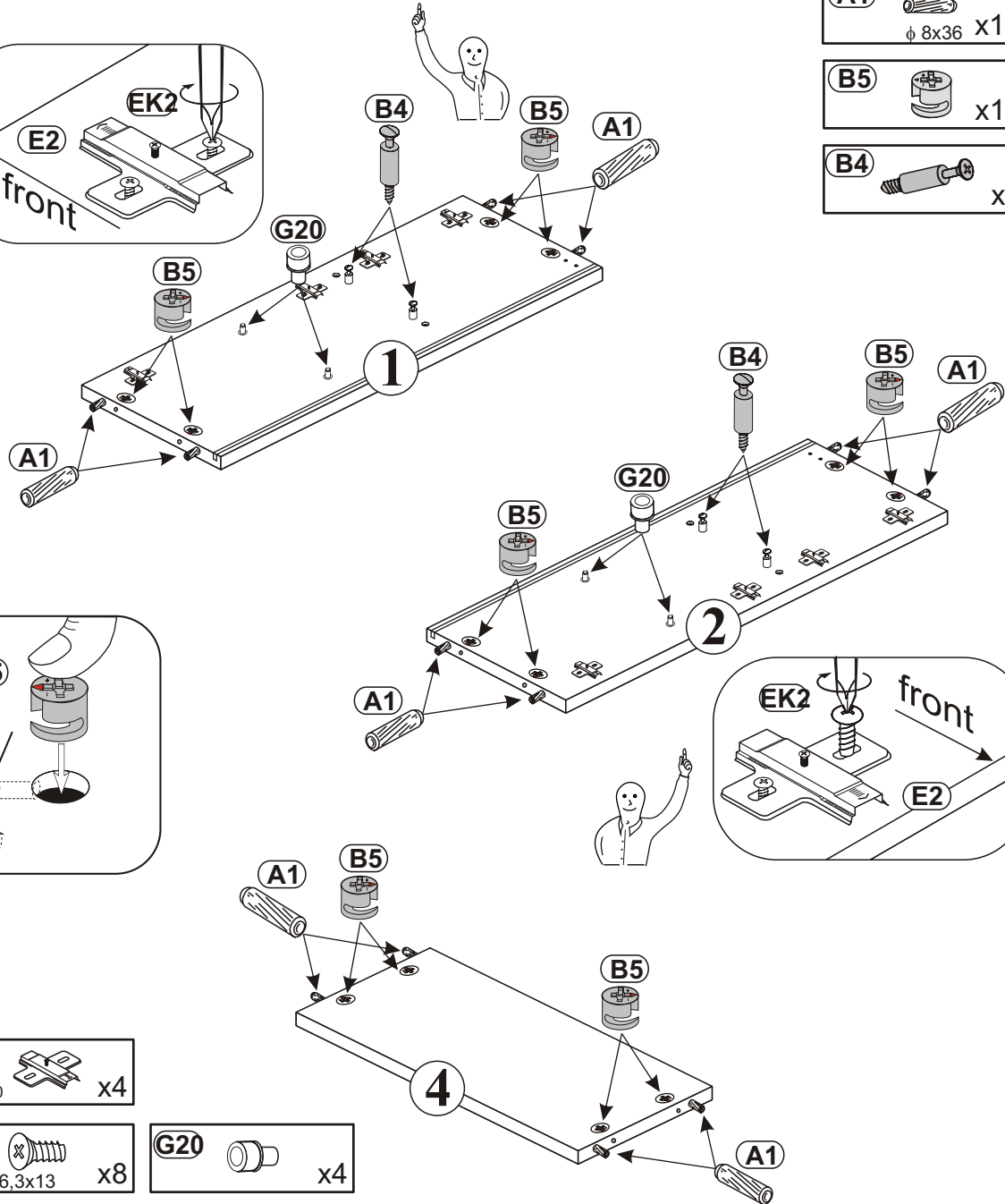
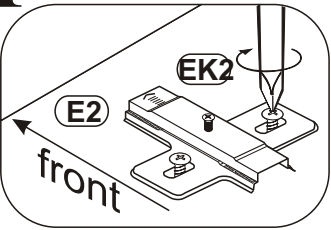

1





A1  x12
 ϕ 8x36

B5  x12

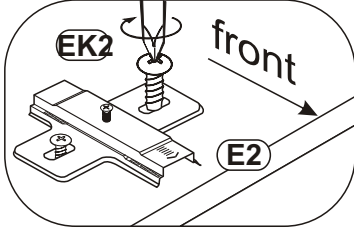
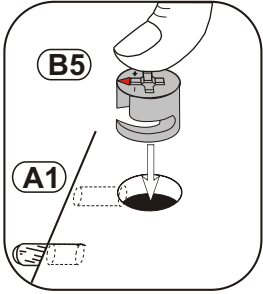
B4  x4



E2  x4
 H0

EK2  x8
 6,3x13

G20  x4

2

B4  x8

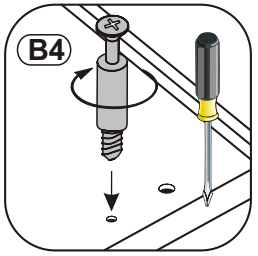
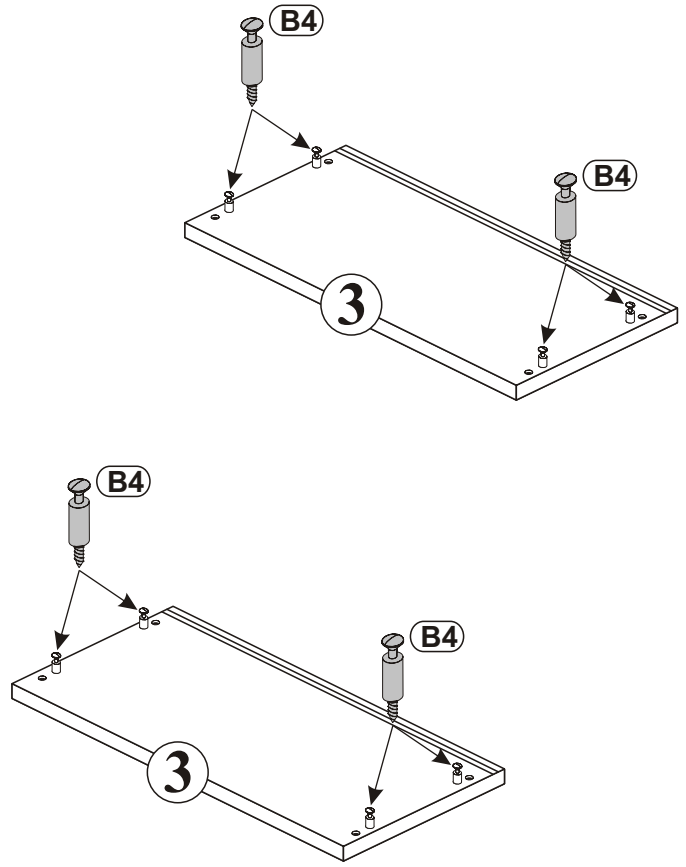

3

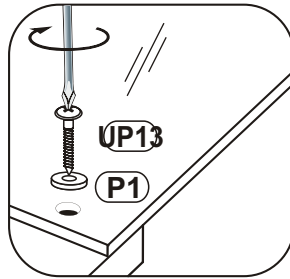
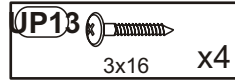
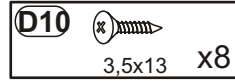
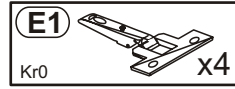
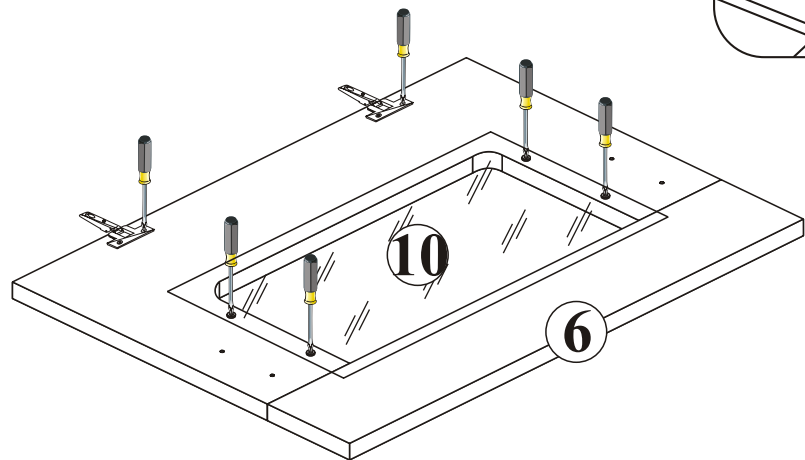
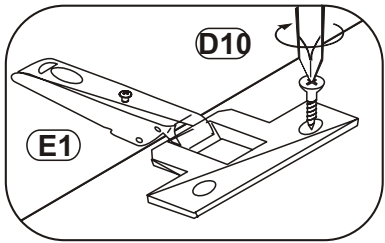
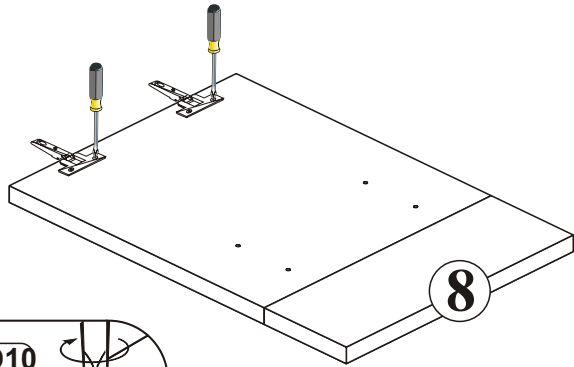

4

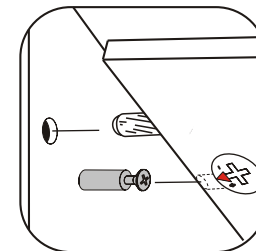
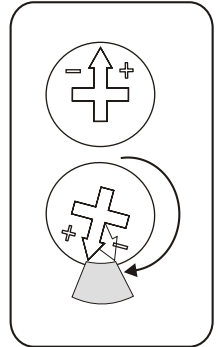
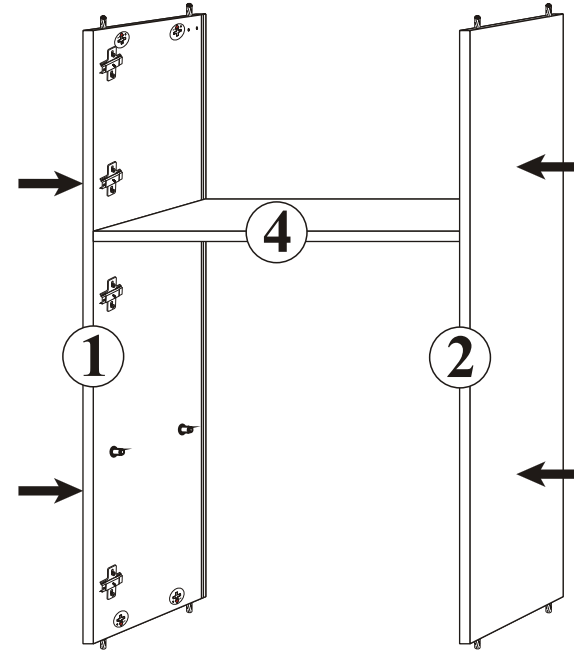

5

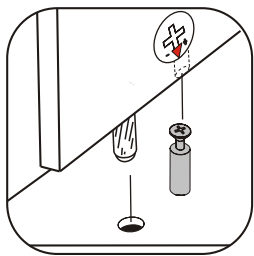
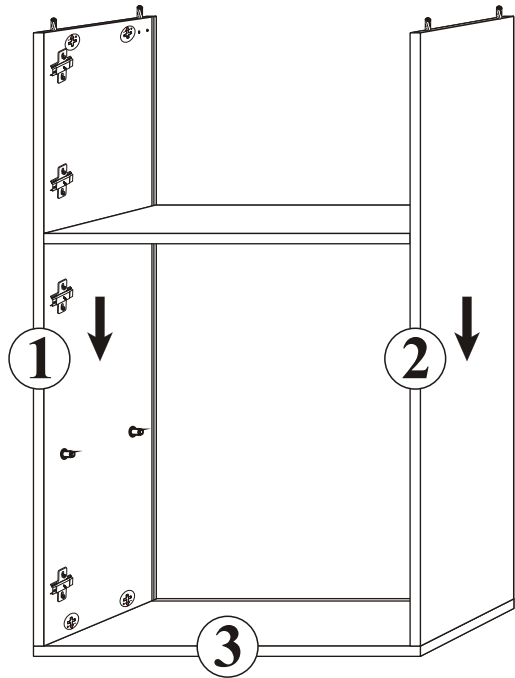

6

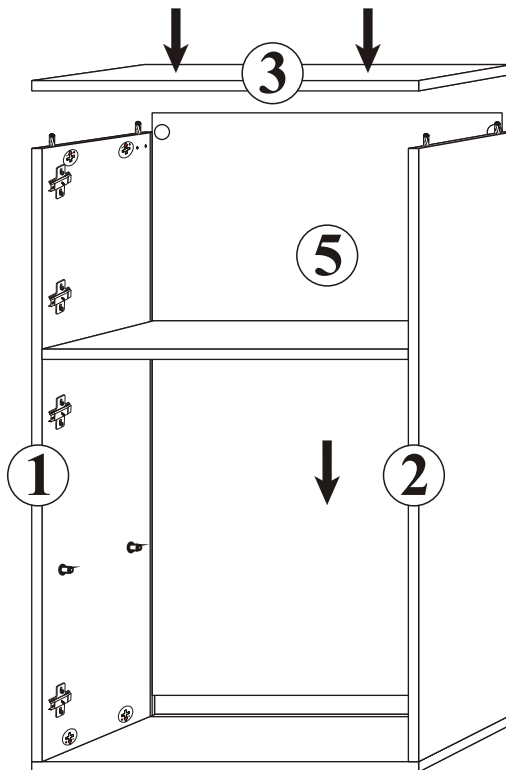
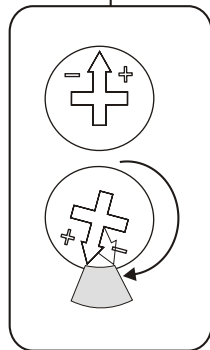
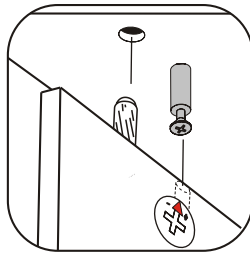

7

S1  x10

a=b

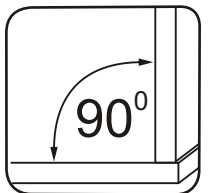
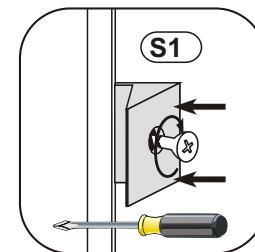
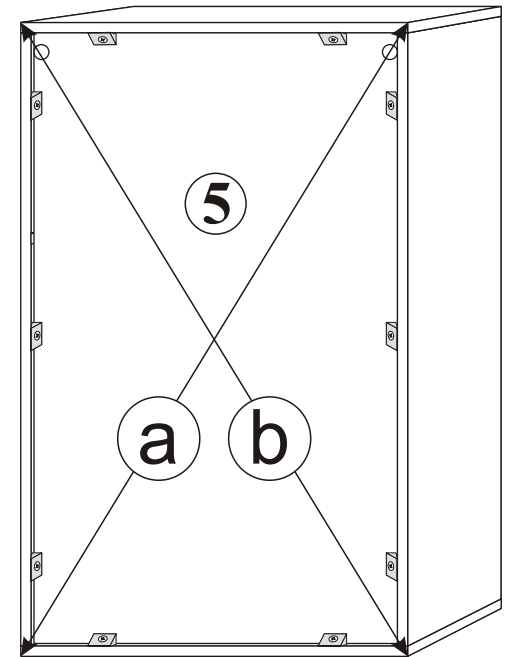

8

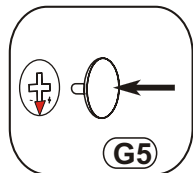
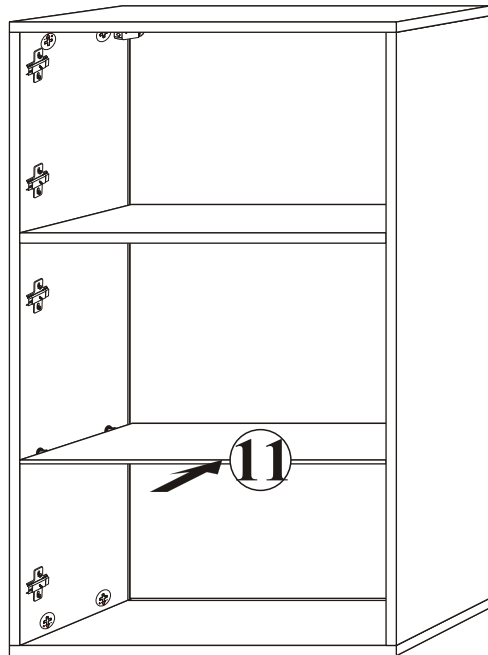
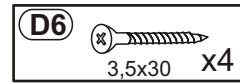
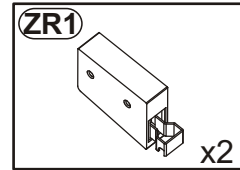
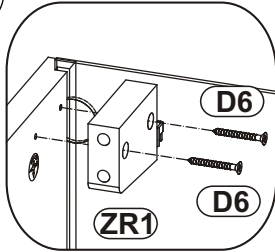

9

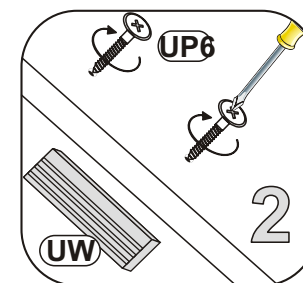
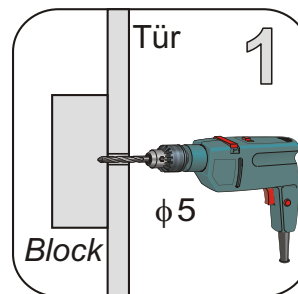
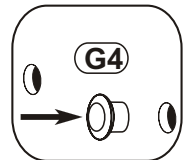
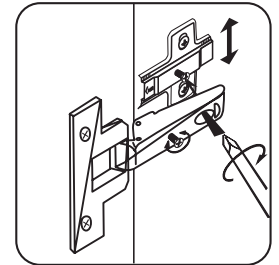
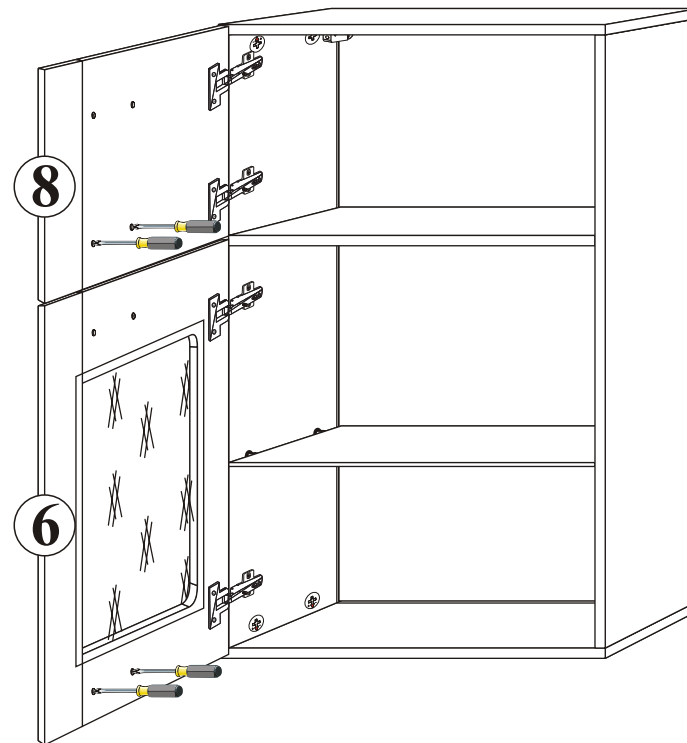
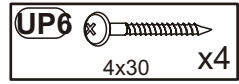
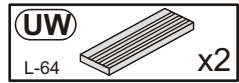
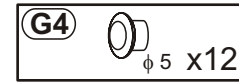

10

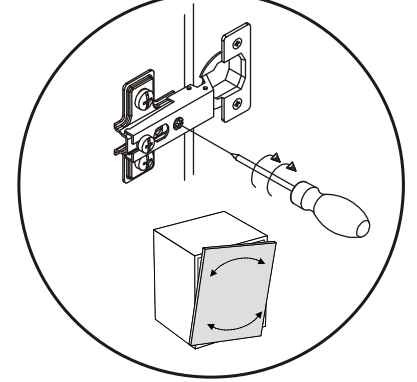
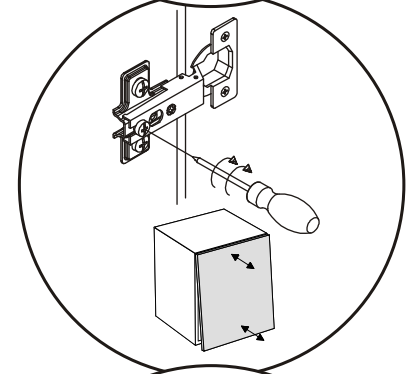
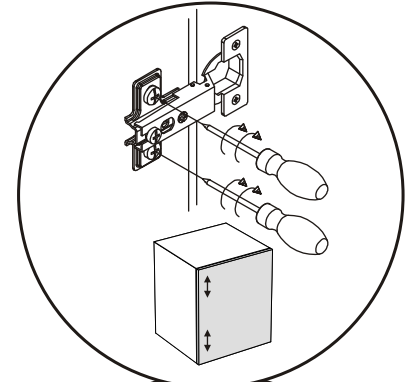
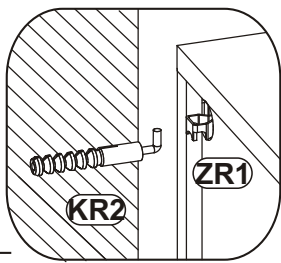
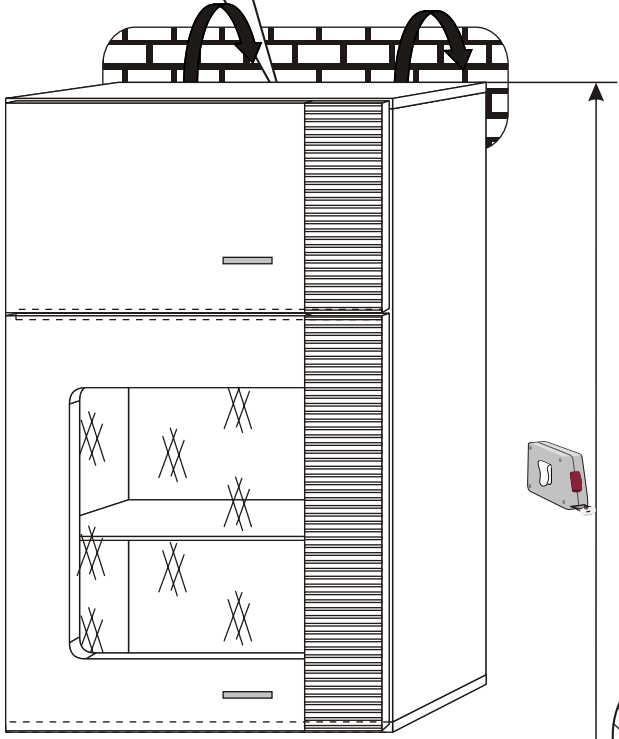
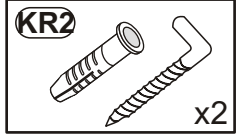
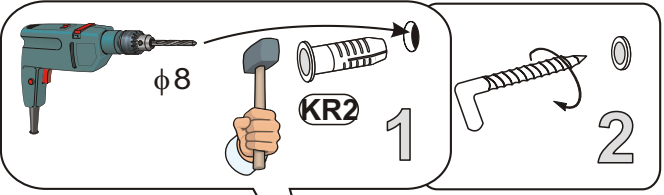

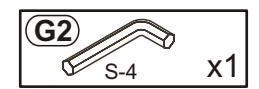
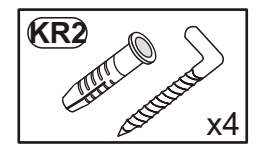
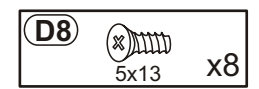
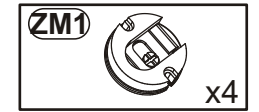
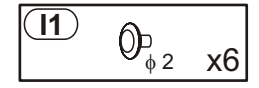
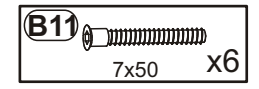
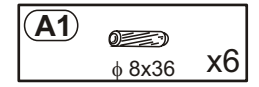
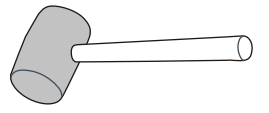
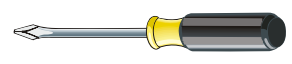
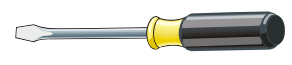
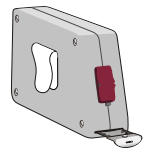
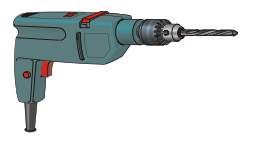
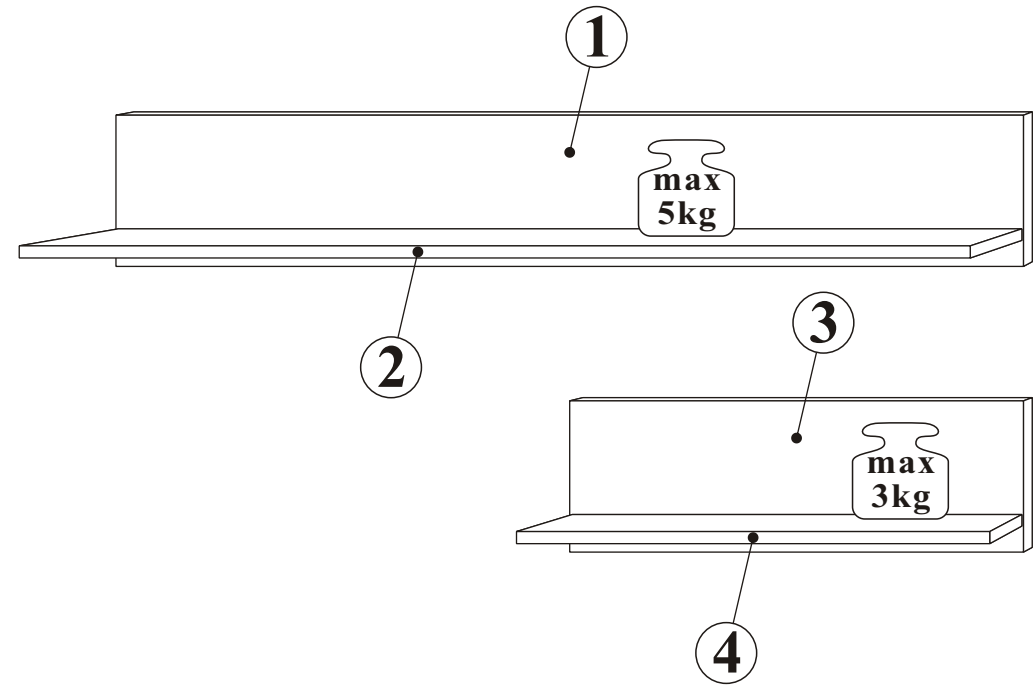
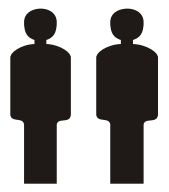
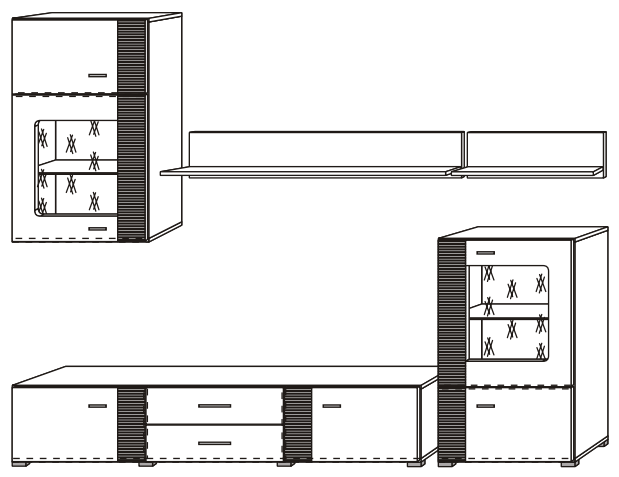

1

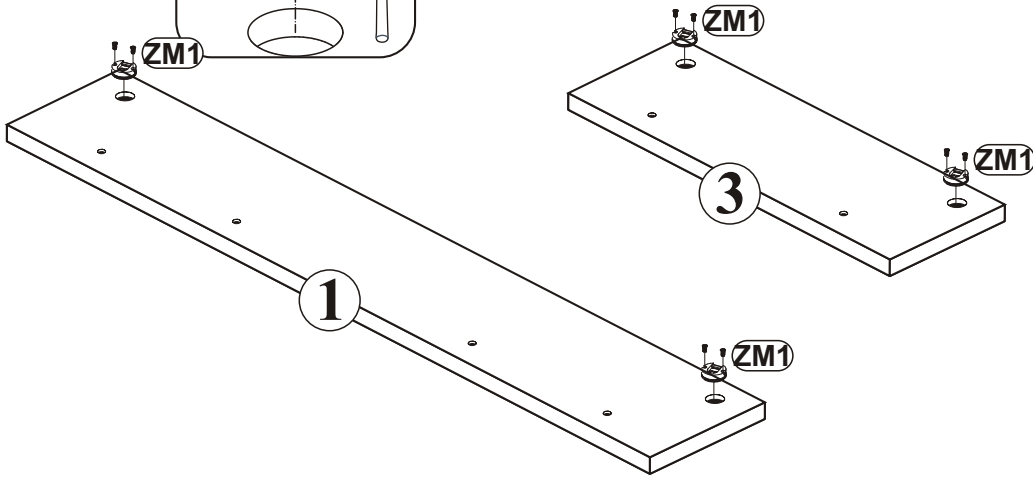
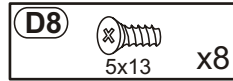
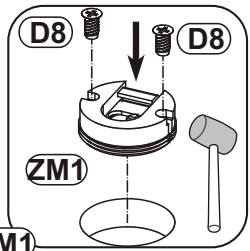

3

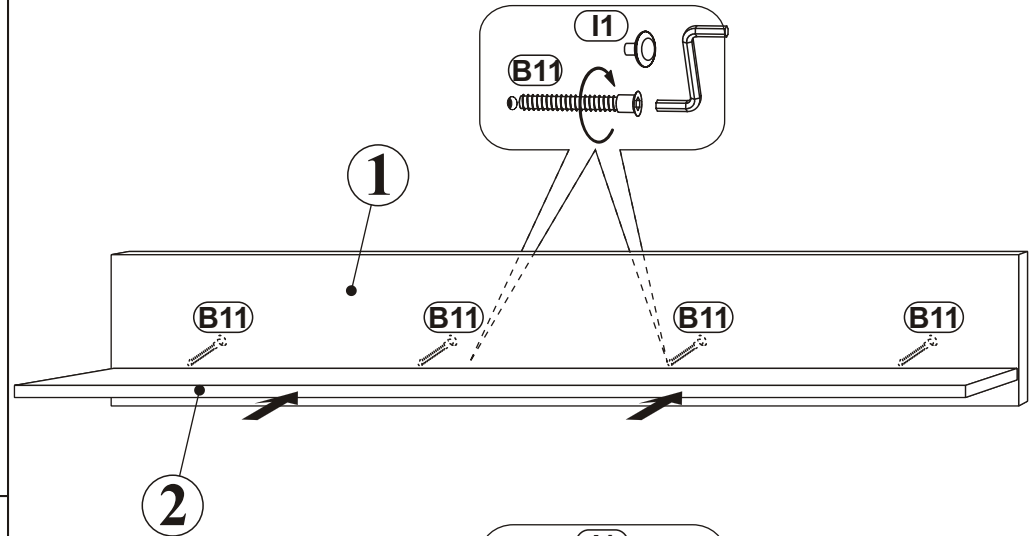
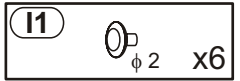
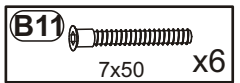

2

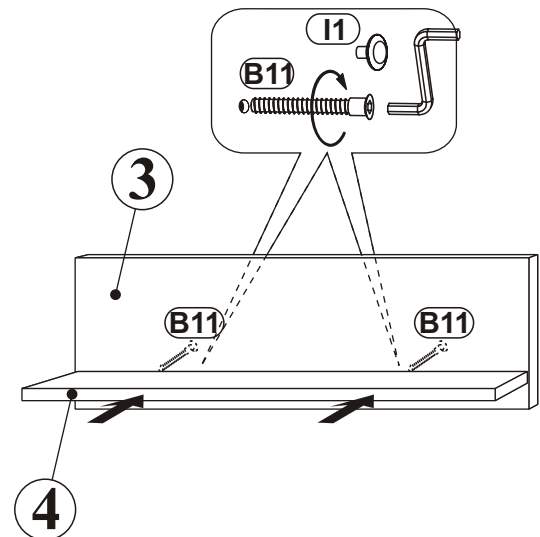
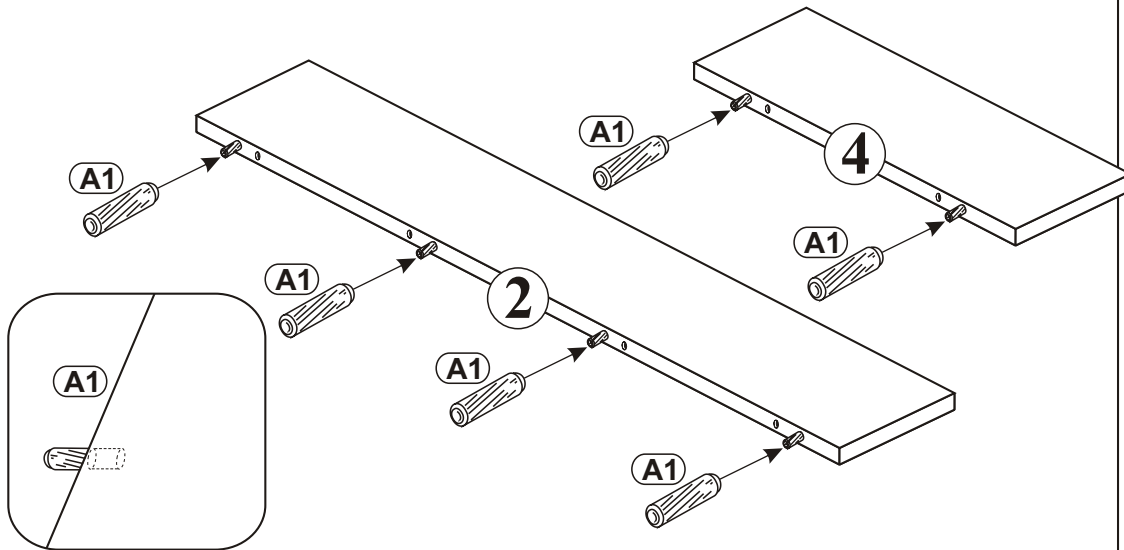
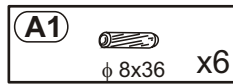

4

