



# RECOMENDACIONES

Recommandations - Consigli - Recomendações -  
Aanbevelingen - Empfehlungen

---







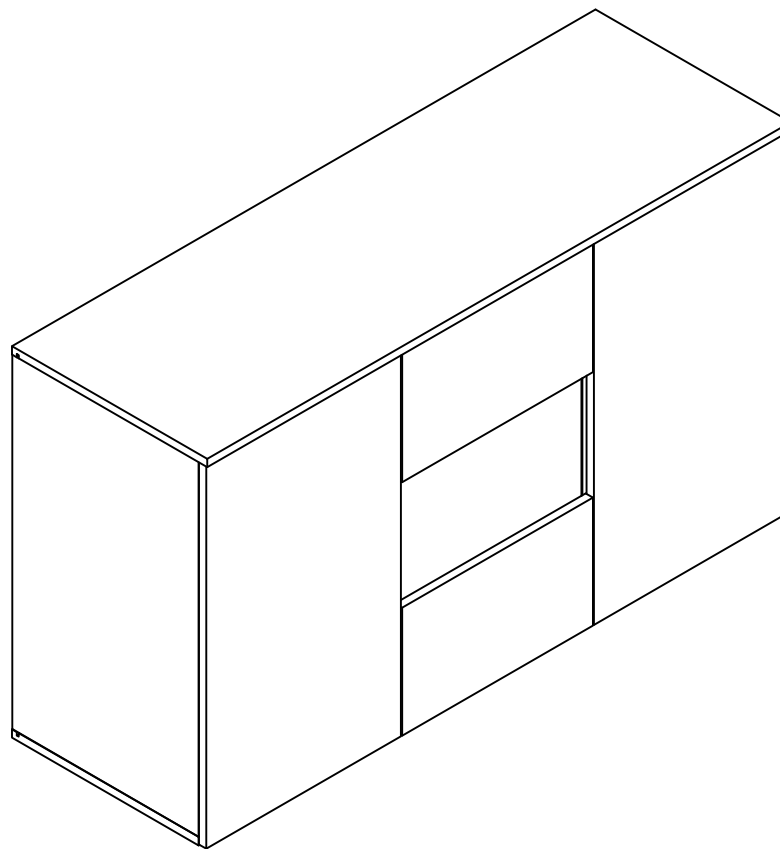

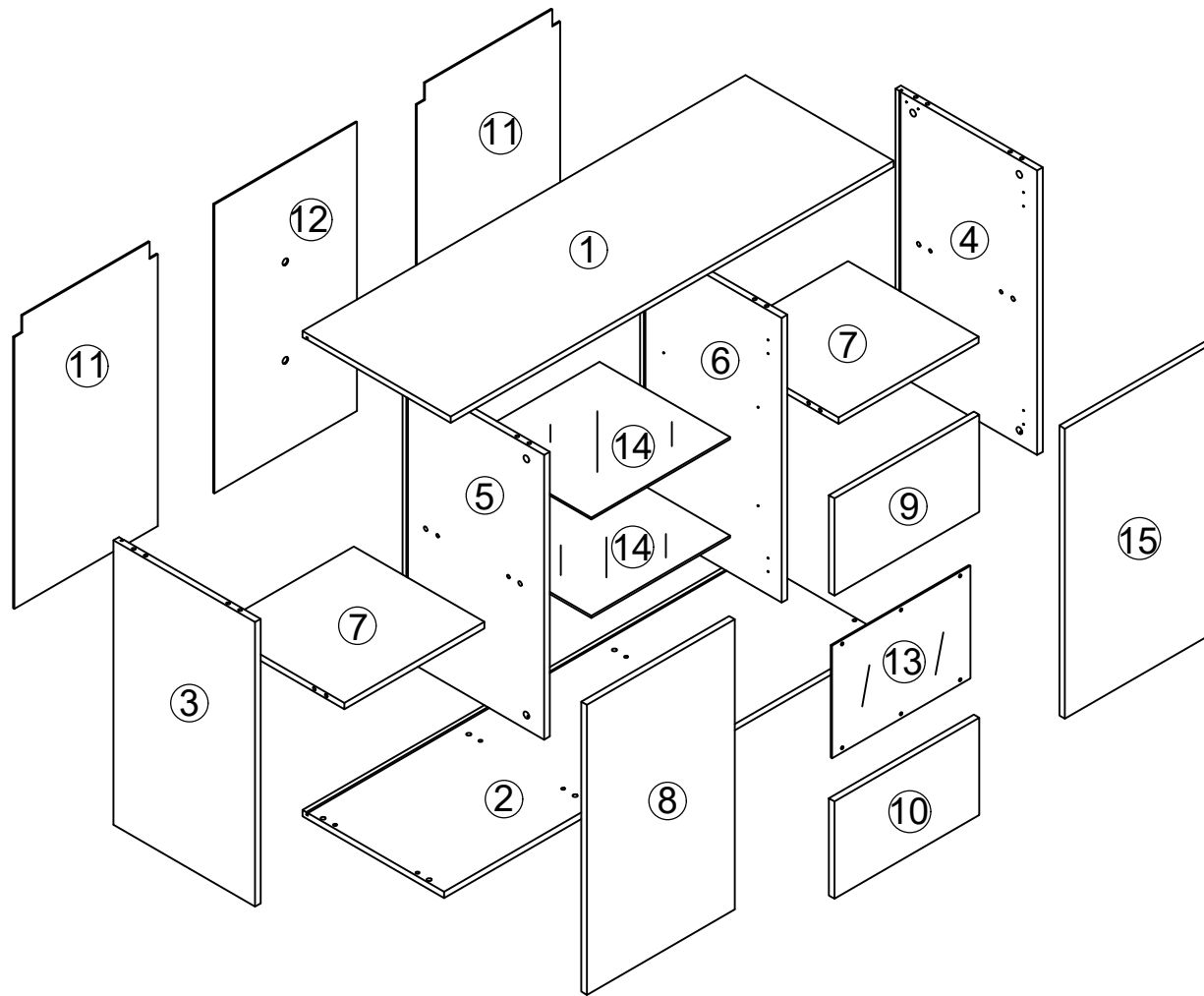
- ES** Los tacos y tornillos incluidos no son aptos para paredes de pladur.
- EN** The included plugs and screws are not suitable for drywall.
- DE** Die mitgelieferten Dübel und Schrauben sind nicht für Gipswände geeignet.
- FR** Les chevilles et les vis fournies ne conviennent pas aux murs en placoplâtre.
- IT** I tasselli e le viti in dotazione non sono adatti alle pareti in cartongesso.
- NL** De meegeleverde pluggen en schroeven zijn niet geschikt voor gipswanden.
- PT** As buchas e os parafusos incluídos não são adequados para paredes de pladur.

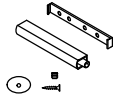

- ES: Escanea este código QR para ver las instrucciones actualizadas y posibles vídeos tutoriales.  
EN: Scan QR code for updated manual and possible tutorial videos.  
FR: Scannez ce code QR pour voir les instructions mises à jour et les vidéos possible.  
IT: Scannerizzate il codice QR per vedere le istruzioni aggiornate ed eventuali tutorial video.  
PT: Faça o scan deste código QR para obter instruções actualizadas e possíveis vídeos.  
NL: Scan de QR code voor de actuele montagehandleiding en eventuele video met uitleg.  
DE: Scannen Sie den QR-Code für die aktuelle Montageanleitung und eventuelle Video-Tutorials.

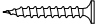
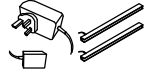
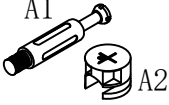
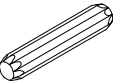
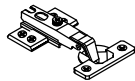
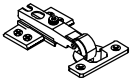
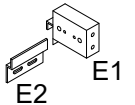

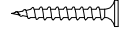
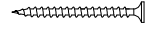
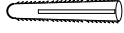

<p>K 6*10</p>  <p>6PCS</p>	<p>L</p>  <p>3PCS</p>	<p>M 3*12</p>  <p>14PCS</p>	<p>N</p>  <p>8PCS</p>	<p>O</p>  <p>5PCS</p>	<p>P 3.5*25</p>  <p>10PCS</p>	<p>LED</p>  <p>1PCS</p>			
<p>A</p>  <p>24PCS</p>	<p>B 8*40</p>  <p>24PCS</p>	<p>C</p>  <p>4PCS</p>	<p>D</p>  <p>2PCS</p>	<p>E</p>  <p>4PCS</p>	<p>F 3.5*14</p>  <p>44PCS</p>	<p>G 3.5*30</p>  <p>8PCS</p>	<p>H 4*50</p>  <p>8PCS</p>	<p>I 8*40</p>  <p>8PCS</p>	<p>J</p>  <p>8PCS</p>

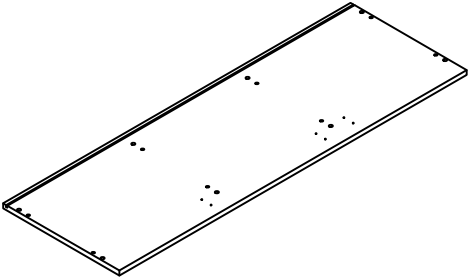
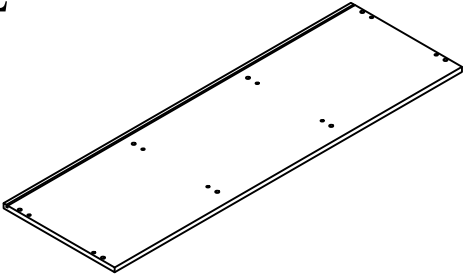
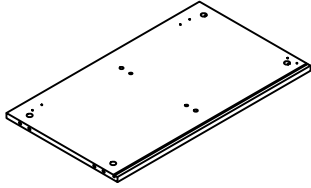
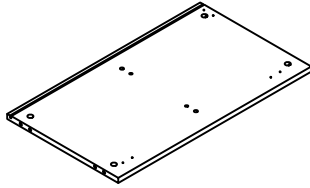
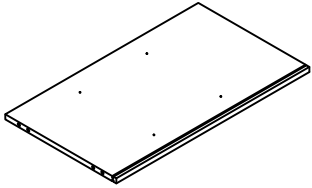
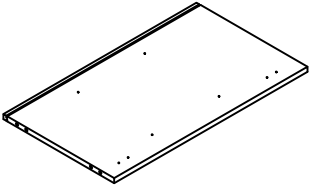
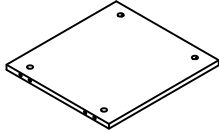
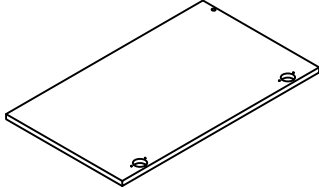
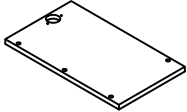
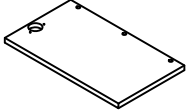
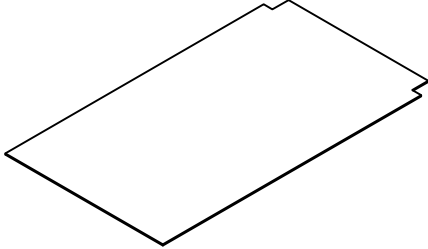
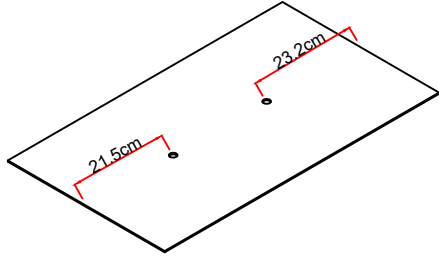
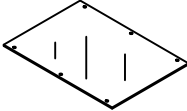
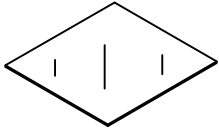
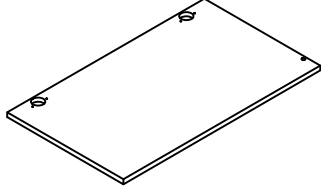
<p>1</p>  <p>1201*402 1PS</p>	<p>2</p>  <p>1201*384 1PS</p>	<p>3</p>  <p>668*384 1PS</p>	<p>4</p>  <p>668*384 1PS</p>
<p>5</p>  <p>668*384 1PS</p>	<p>6</p>  <p>668*384 1PS</p>	<p>7</p>  <p>380*354 2PS</p>	<p>8</p>  <p>681*401 1PS</p>
<p>9</p>  <p>393*228 1PS</p>	<p>10</p>  <p>393*228 1PS</p>	<p>11</p>  <p>678*389 2PS</p>	<p>12</p>  <p>678*387 1PS</p>
<p>13</p>  <p>375*264 1PS</p>	<p>14</p>  <p>377*354 2PS</p>	<p>15</p>  <p>681*401 1PS</p>	

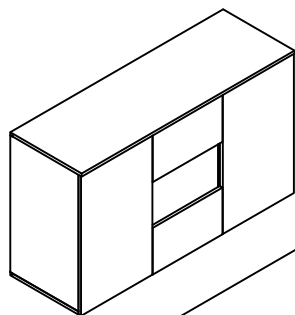

(EN) Assembly of the hanging sideboard.  
(ES) Montaje del aparador colgante.  
(FR) Montage du buffet suspend.  
(IT) Montaggio della credenza sospesa.  
(PT) Montagem do aparador suspenso.  
(NL) Montage als hangend dressoir.  
(DE) Montage als Wandsideboard.

(EN) Steps  
(ES) Pasos  
(FR) Étapes  
(IT) Passi  
(PT) Passos  
(NL) Stappen  
(DE) Schritte

① ② ④ ⑤ ⑥ ⑦ ⑧ ⑨ ⑩

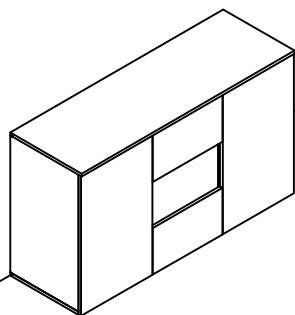

(EN) Assembly of the standing sideboard with legs.  
(ES) Montaje del aparador con patas.  
(FR) Montage du buffet sur pieds  
(IT) Montagem do aparador com pés.  
(PT) Montagem do aparador com pés.  
(NL) Montage als staand dressoir  
(DE) Montage als Sideboard mit Füßen

(EN) Steps  
(ES) Pasos  
(FR) Étapes  
(IT) Passi  
(PT) Passos  
(NL) Stappen  
(DE) Schritte

① ② ③ ④ ⑤ ⑥ ⑦ ⑧

1

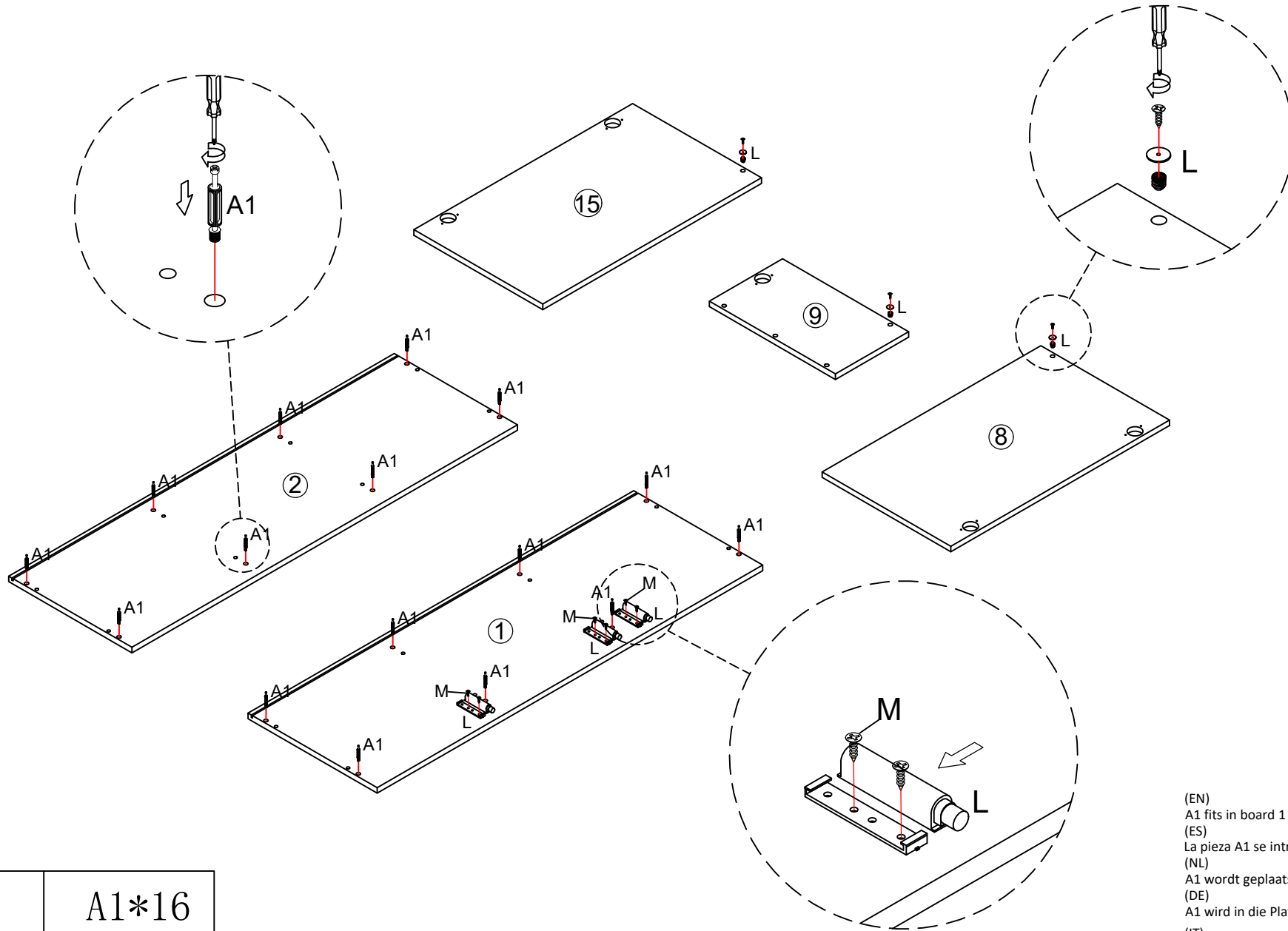

(EN)  
A1 fits in board 1 2  
(ES)  
La pieza A1 se introduce en los tableros 1 2  
(NL)  
A1 wordt geplaatst in de panelen 1 2  
(DE)  
A1 wird in die Platten 1 2 eingesetzt.  
(IT)  
Il pezzo A1 si inserisce nei pannelli 1 2  
(FR)  
La pièce A1 s'insère dans les planches 1 2  
(PT)  
A peça A1 insere-se nas tábuas 1 2

	A1*16
	L*3
	M*6

2

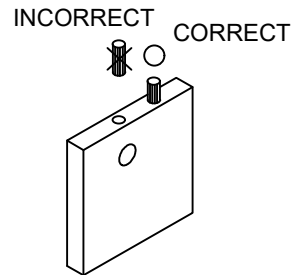
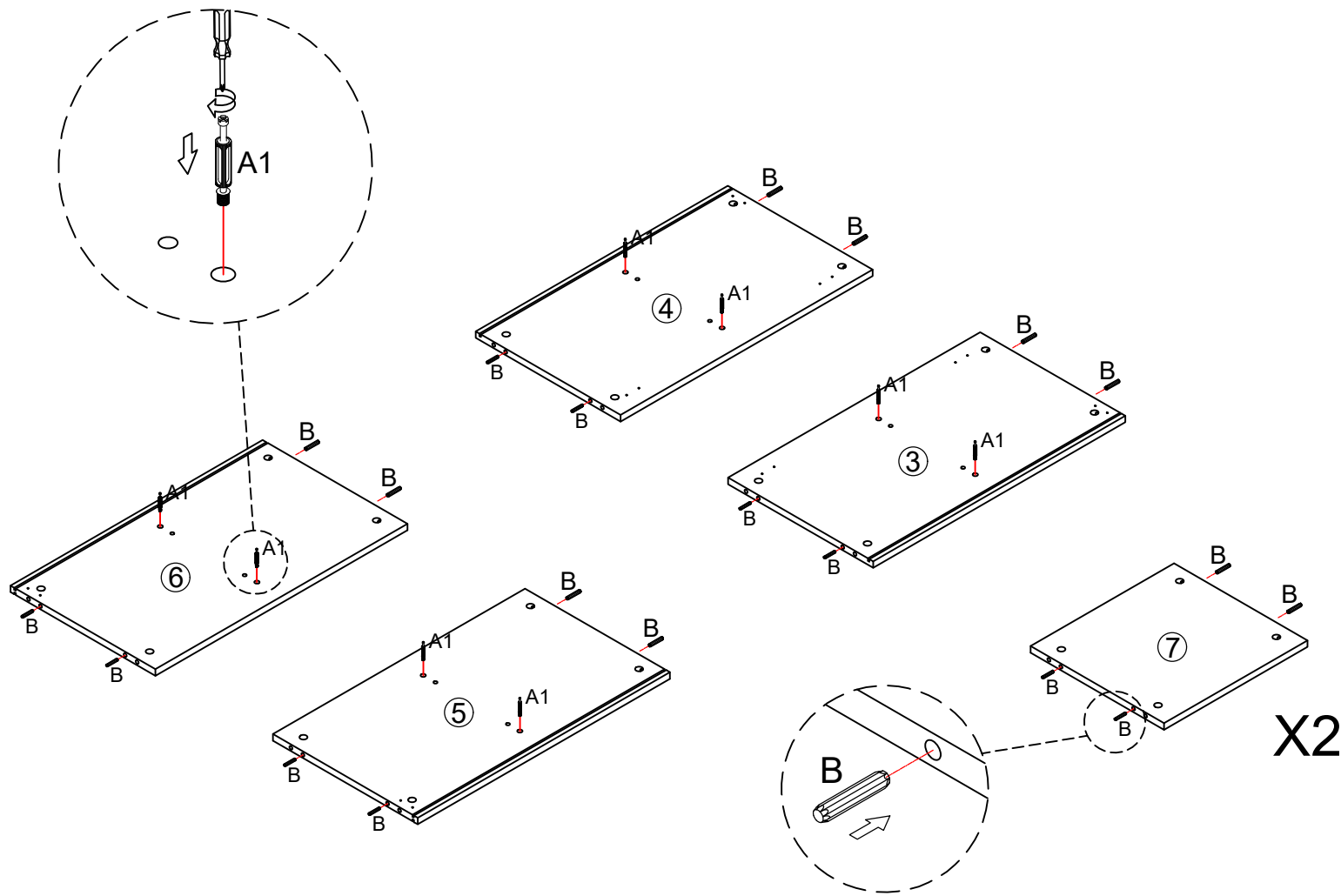

X2

(EN)  
 A1 fits in board 3 4 5 6  
 B fits in board 3 4 5 6 7

(IT)  
 Il pezzo A1 si inserisce nei pannelli 3 4 5 6  
 Il pezzo B si inserisce nei pannelli 3 4 5 6 7

(ES)  
 La pieza A1 se introduce en los tableros 3 4 5 6  
 La pieza B se introduce en los tableros 3 4 5 6 7

(FR)  
 La pièce A1 s'insère dans les planches 3 4 5 6  
 La pièce B s'insère dans les planches 3 4 5 6 7

(NL)  
 A1 wordt geplaatst in de panelen 3 4 5 6  
 B wordt geplaatst in de panelen 3 4 5 6 7

(PT)  
 A peça A1 insere-se nas tábuas 3 4 5 6  
 A peça B insere-se nas tábuas 3 4 5 6 7

(DE)  
 A1 wird in die Platten 3 4 5 6 eingesetzt.  
 B wird in die Platten 3 4 5 6 7 eingesetzt



A1\*8



B\*24

3

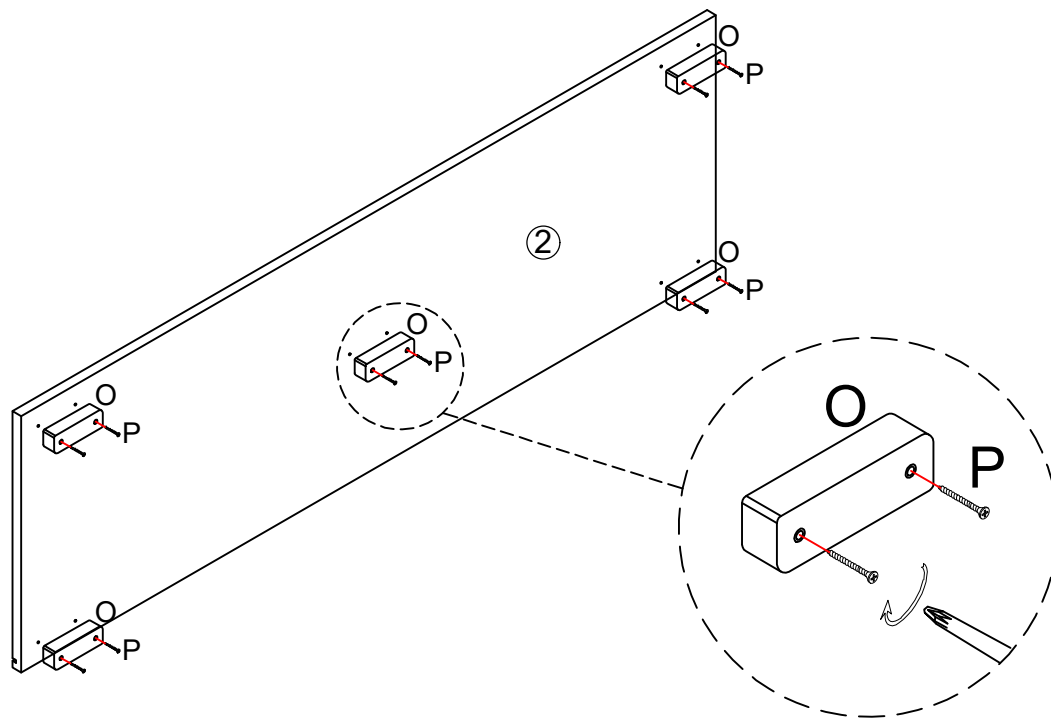

P\*10



O\*5



# 4

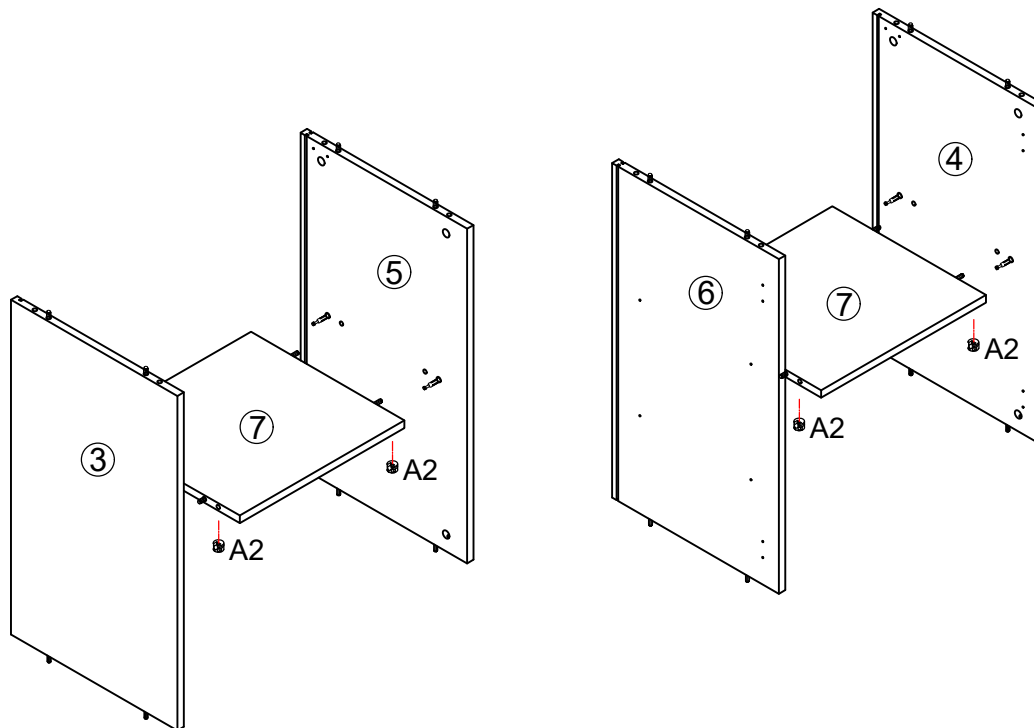
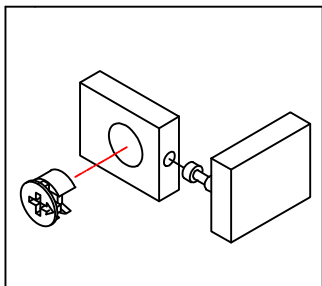

(EN)

Make sure that the arrow on the minifix body (A2) is faced to the hole of the board which will be assembled.

(ES)

Asegúrese de que la flecha de la excéntrica (pieza A2) tiene que estar orientada a la perforación del tablero al cual se va a unir.

(NL)

Let op: De pijl op de excentrische meubelverbinder (onderdeel A2) moet gericht zijn naar de boring van het paneel waarop hij moet worden bevestigd.

(DE)

Hinweis: Der Pfeil auf dem exzentrischen Möbelverbinder (A2) muss auf die Bohrung der Platte zeigen, an der er befestigt werden soll.

(PT)

Tenha certeza de que a seta do excêntrico (peça A2) deve estar orientada para a perfuração da tábuas à qual vai unir-se.

(FR)

Assurez-vous que la flèche de l'excentrique (pièce A2) doit être orientée vers la perforation de la planche à laquelle elle va être jointe.

(IT)

Assicurarsi che la freccia dell'eccentrico (pezzo A2) sia orientata alla perforazione del pannello a cui andrà ad unirsi.

(EN)

A2 fits in board 7

(ES)

La pieza A2 se introduce en los tableros 7

(NL)

A2 wordt geplaatst in de panelen 7

(DE)

A2 wird in die Platten 7 eingesetzt

(IT)

Il pezzo A2 si inserisce nei pannelli 7

(FR)

La pièce A2 s'insère dans les planches 7

(PT)

A peça A2 insere-se nas tábuas 7



A2\*8

5

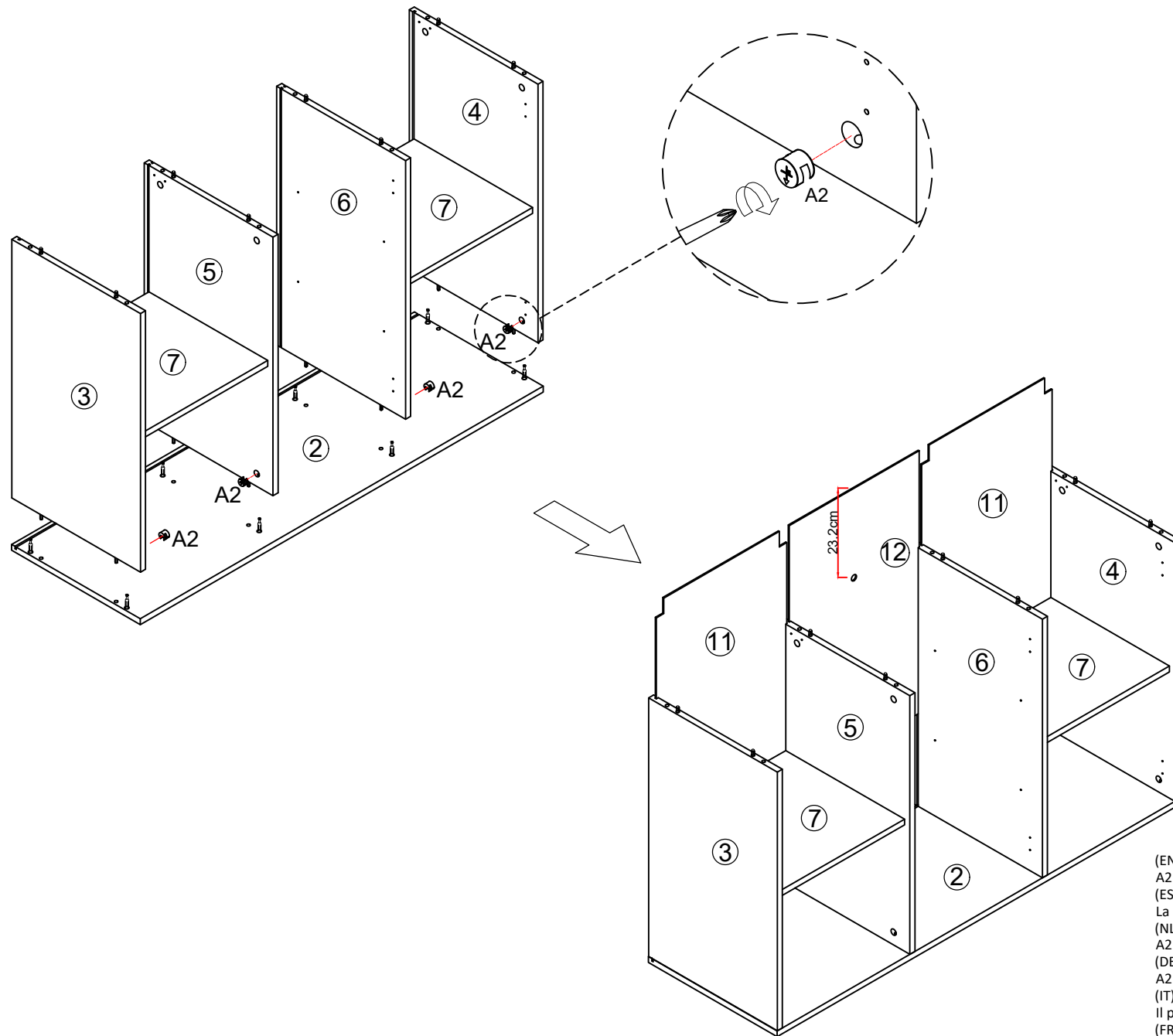

- (EN) A2 fits in board 3 4 5 6
- (ES) La pieza A2 se introduce en los tableros 3 4 5 6
- (NL) A2 wordt geplaatst in de panelen 3 4 5 6
- (DE) A2 wird in die Platten 3 4 5 6 eingesetzt
- (IT) Il pezzo A2 si inserisce nei pannelli 3 4 5 6
- (FR) La pièce A2 s'insère dans les planches 3 4 5 6
- (PT) A peça A2 insere-se nas tábuas 3 4 5 6



A2\*8

6

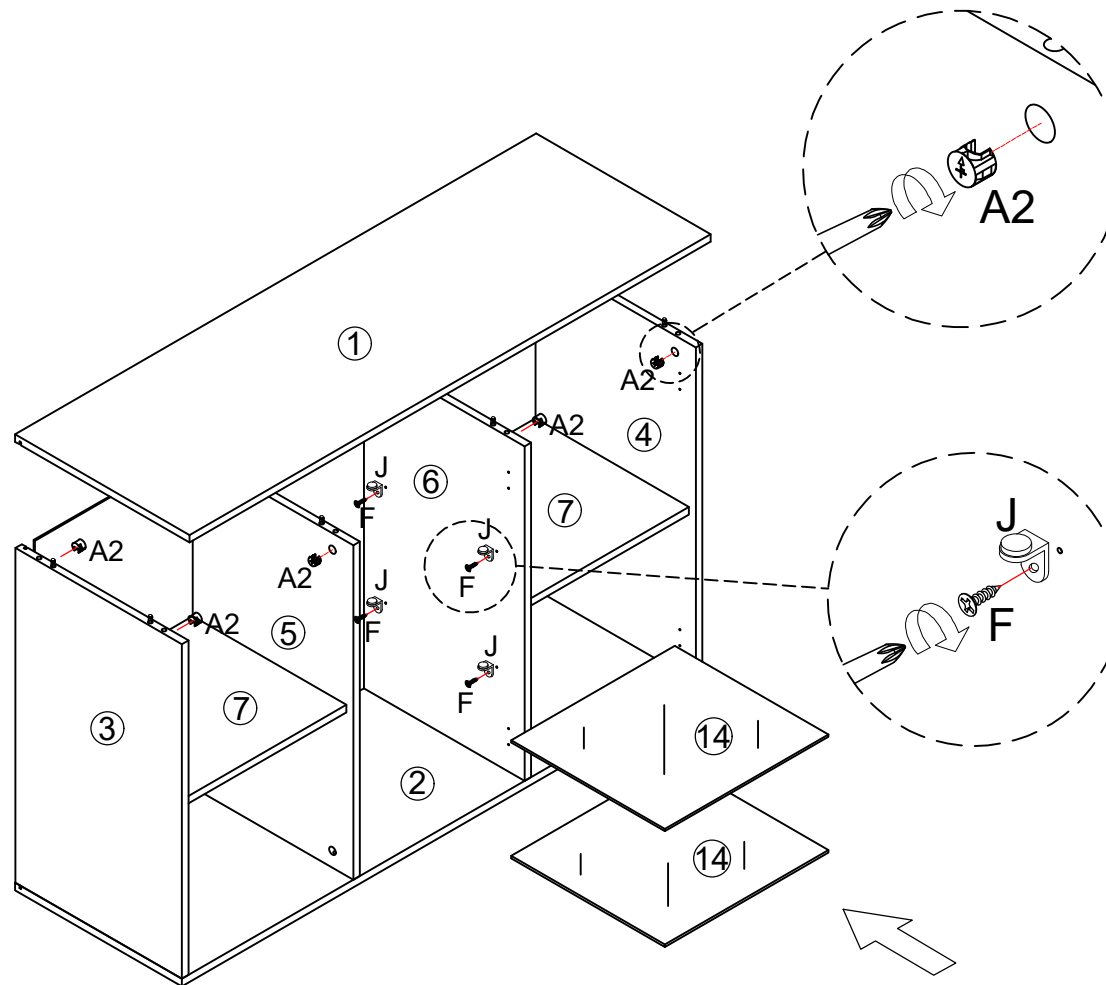

(EN)  
A2 fits in board 3 4 5 6  
(ES)  
La pieza A2 se introduce en los tableros 3 4 5 6  
(NL)  
A2 wordt geplaatst in de panelen 3 4 5 6  
(DE)  
A2 wird in die Platten 3 4 5 6 eingesetzt  
(IT)  
Il pezzo A2 si inserisce nei pannelli 3 4 5 6  
(FR)  
La pièce A2 s'insère dans les planches 3 4 5 6  
(PT)  
A peça A2 insere-se nas tábuas 3 4 5 6



A2\*8



F\*8



J\*8

7

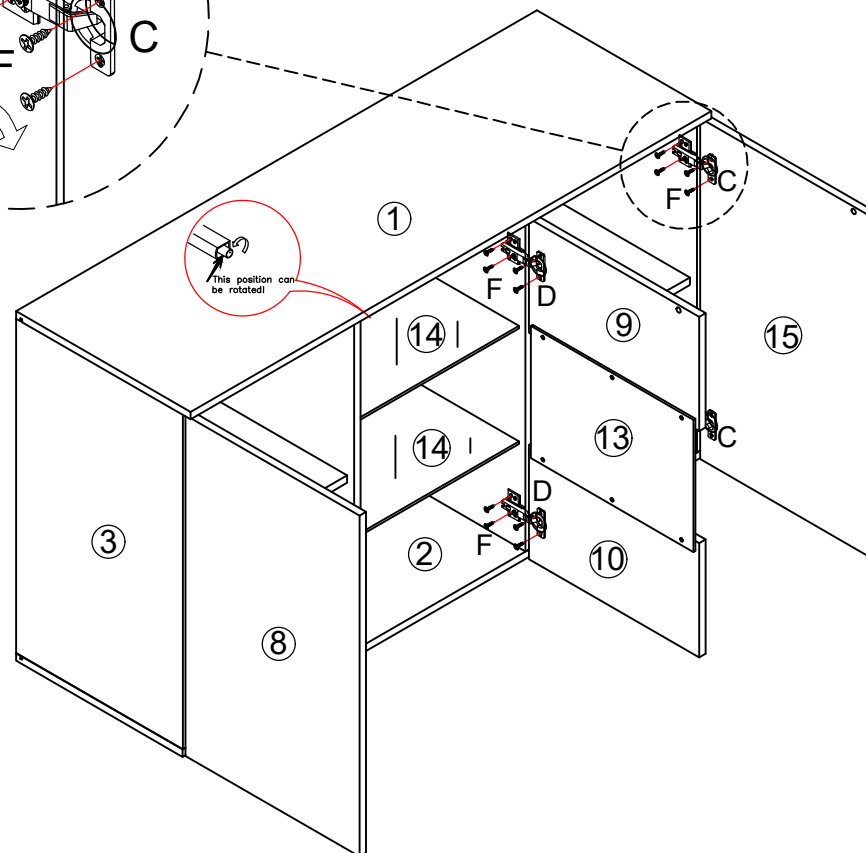
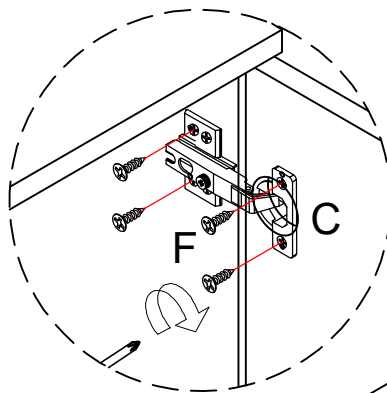
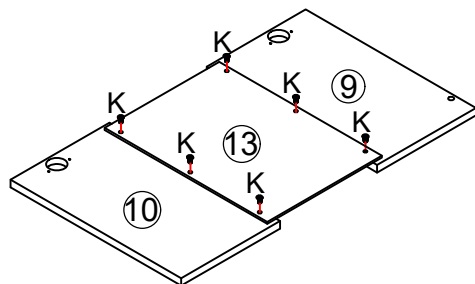

(EN) Piece number 13 is covered by an adhesive that must be removed.

(ES) La pieza 13 está cubierta por un adhesivo que debe ser retirado.

(FR) L'adhésif est recouvert de la pièce 13 et doit être enlevé.

(IT) Il pezzo numero 13 è ricoperto da un adesivo che deve essere rimosso.

(PT) A peça número 13 está coberta por um adesivo que deve ser removido.

(NL) Onderdeel nummer 13 is voorzien van een beschermende folie welke verwijderd dient te worden.

(DE) A peça número 13 está coberta por um adesivo que deve ser removido.

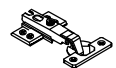
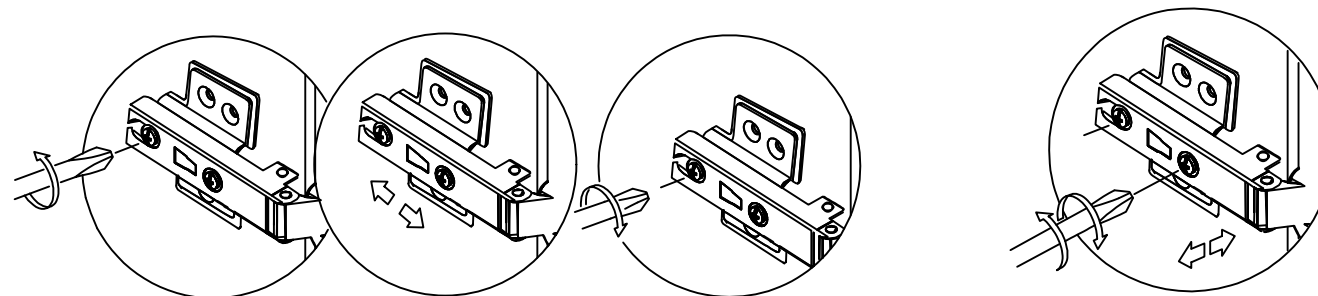

C\*4

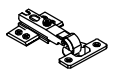

D\*2



F\*36



K\*6

8

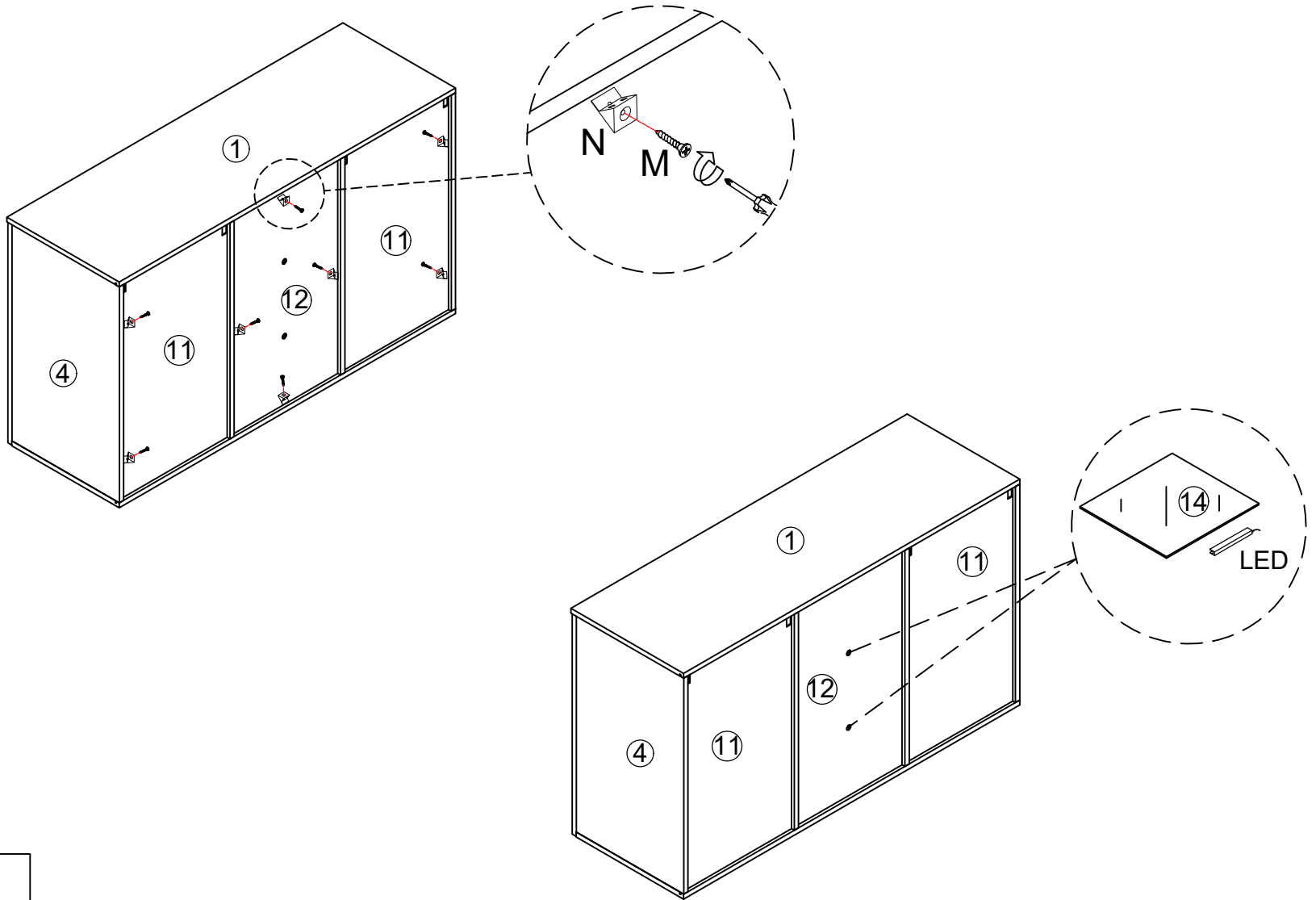

N\*8



M\*8



LED

9

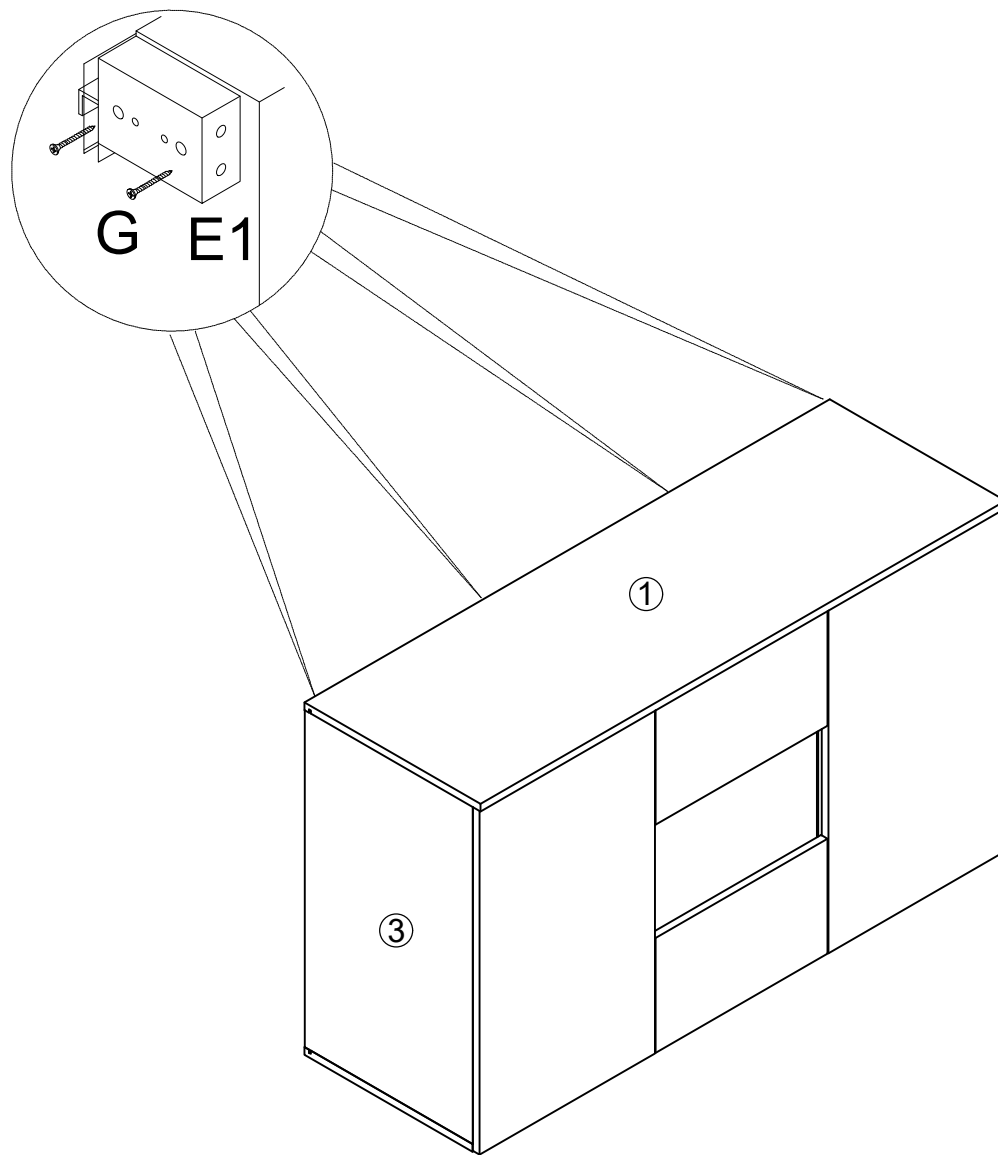



E1\*4

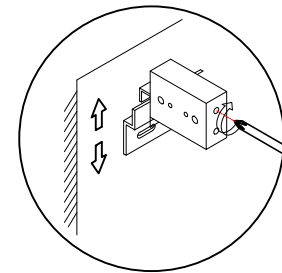
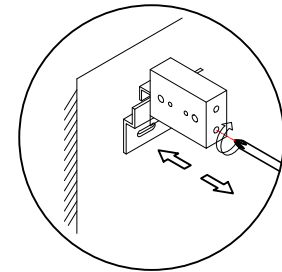
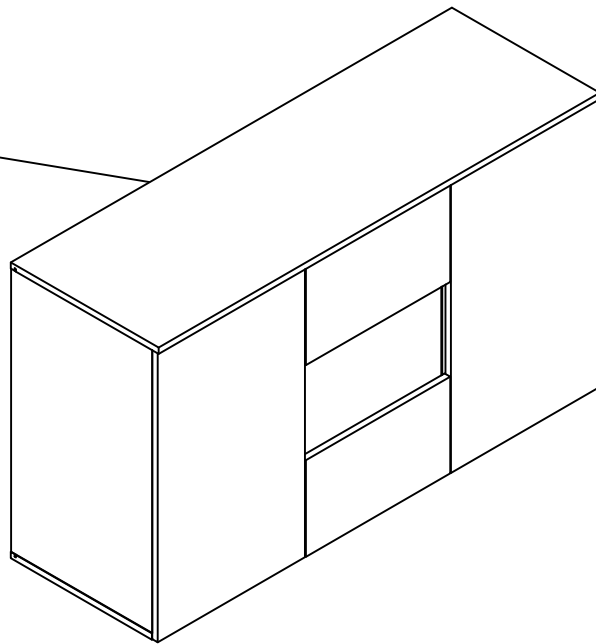
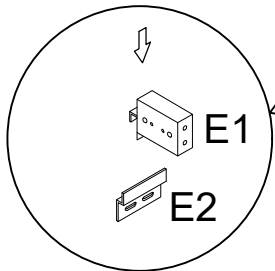
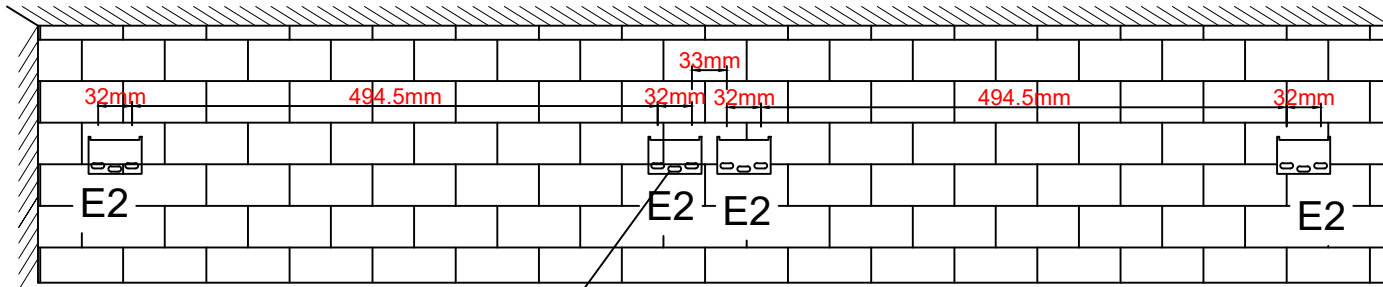
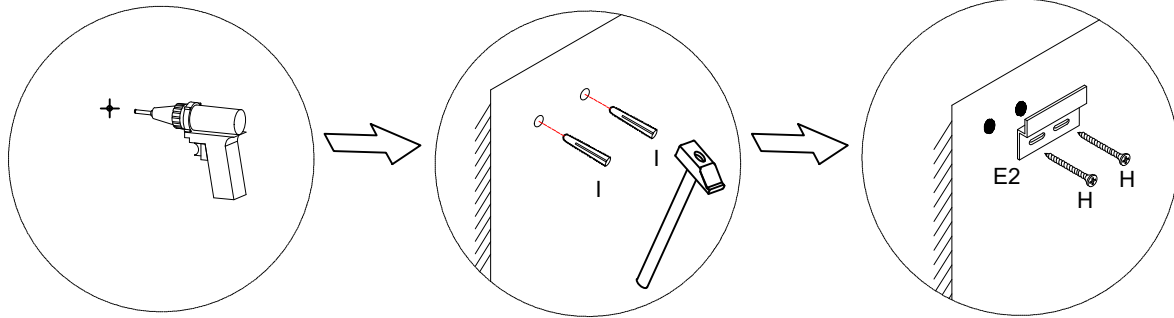

G\*8

10

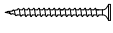
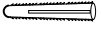

	H*8
	I*8
	E2*4